

ACCESSIBLE PLANNING

Diverse and individual solutions for
comfortable and convenient bathrooms

CONTENTS



Private homes _____ 4

Planning ahead and exploiting potential



Care facilities _____ 10

Efficiently supporting patients and staff



Public areas _____ 14

Economic solutions for public areas



DIN standards _____ 18

Overview of dimensions and specifications



Product range _____ 22

Concise overview of the product range



References _____ 50

Villeroy & Boch PROJECTS



Everything for your project _____ 51

We will be pleased to advise you!

THE BATHROOM STYLE OF THE FUTURE: ACCESSIBILITY

Accessibility is an essential attribute of future-viable architecture. Realising accessibility involves many practical issues: how can a private bathroom be modernised for the future in a cost-efficient way? What fittings and furnishings meet the requirements of a care facility? What aspects need to be considered in the area of public sanitary facilities? This factbook highlights the most important requirements and provides you with clear guidance on choosing appropriate fittings and furnishings.

All set for the future

Life expectancy is rising. Projections indicate that on average a man will live to the age of 84.4 and a woman will reach the age of 88.1 in Germany in 2060*. This will give rise to a marked increase in the need for accessible bathrooms tailored to the needs of the elderly. This is a challenge facing all areas of society, from the political sphere through the property market to the building sector. Villeroy & Boch is addressing this challenge with a diverse range of user-friendly and appealing solutions.

Helping to shape the course of change

We see the process of demographic change as an opportunity – a chance for investors to increase the appeal of properties by means of bathrooms designed for the older generations, while avoiding the need for extensive alterations in the future; a chance to rethink independence and support in everyday life at care facilities; and a springboard for creating public areas in keeping with a modern, inclusive society.

Discover our ergonomically designed products and our DIN standard-compliant ViCare collection. For accessible bathroom planning which takes all areas of life and attendant needs fully into account.



* <https://de.statista.com/statistik/daten/studie/273406/umfrage/entwicklung-der-lebenserwartung-bei-geburt-in-deutschland-nach-geschlecht>



AN ACCESSIBLE BATHROOM IS A VALUABLE ASSET

Accessible homes are a lucrative growth market – on top of the prevailing high demand for residential space. Investing in a corresponding fit-out will substantially increase the value of your property. Make the most of the possibilities: plan accessible bathrooms for markedly higher returns in future.

Accessible homes – more popular than ever

The share of elderly people in the population is continually growing. Most of these people wish to continue living independently in their own homes for as long as possible in old age. You can play a key role in helping them to do so with an accessible bathroom designed for safety, comfort and convenience.

Major potential, little additional outlay

We are continually developing new product solutions to cover all aspects of accessible bathroom planning. The points at which fastening elements are installed in the walling alongside toilet installation systems in new buildings today can be used at a later point in time as a straightforward means of attaching handles, for example. Well-considered and future-viable bathroom planning with the product range from Villeroy & Boch makes easy work of subsequent retrofitting to meet future needs.

Attractive design, attractive returns

Fitting out or preparing a bathroom for accessibility boosts the property's value and yields higher returns. Investors can even obtain grants for their building projects. As such, accessibility provides a good means of enhancing the value and appeal of residential properties at little additional outlay. Villeroy & Boch design is an attractive proposition on all fronts.

Installing accessible bathrooms in Germany

- Building projects to adapt homes to accessibility needs qualify for government grants
- Products used in bathrooms must comply with the relevant DIN standard
- In large-scale properties, 20 % of all bathrooms must be wheelchair-compatible in accordance with DIN 18040
- Bathrooms are classified as accessible when they are prepared for accessibility. The actual fit-out can take place at a later juncture.



Looks good, feels safe

Our **ViCare collection** allows you to create an accessible bathroom offering style and comfort. A place to feel secure and at home in. Any additional items, such as handles or a shower seat, can be retrofitted in a straightforward manner as needs arise. The **ViCare collection** can be combined with items from other collections and our high-quality bathroom furniture, thus opening up additional scope for individual design.



SMART PLANNING IS A GOOD INVESTMENT

Ensure accessibility in your properties and add significant value to your portfolio. With our ViCare collection you can accommodate users' individual needs for accessible bathrooms in their private homes – and make your property even more attractive for buyers and tenants into the bargain.



Many different aspects need to be considered when designing rooms and buildings for accessibility. Apart from the legal requirements, the primary focus is on the residents' crucial needs, which are forever changing. Do the living areas need to be wheelchair-compatible, or is it sufficient to offer preparatory measures for an accessibility retrofit? Adequate space for free movement is always necessary. Another key consideration is ensuring that the living areas remain attractive and welcoming. A mirror with ambient lighting and appealing bathroom furniture provide the desired feel-good atmosphere.



What are the defining features of the ViCare collection?

- Rounded edges
- Handles and supporting features for safety and assurance
- Quick 1-point wall mounting for the Design range
- Ergonomic and timeless design
- Dirt-repellent surface finish (CeramicPlus)
- Combinable with matching ViConnect installation systems
- ViCare collection can be installed in accordance with the specifications of the DIN 18040 standard

Your partner for accessible bathrooms

You will find an initial overview of the relevant standards and our products on pages 18 to 21. We have an appropriate solution to every problem.

When choosing fittings and furnishings for an accessible bathroom, it's worth considering details and additional features. These make everyday life easier and enhance the value of the room.

ViConnect washbasin installation element

Installation systems for dry-wall installation

92214900

W 525 x H 1120 x D 75 mm

ViConnect installation elements offer the broadest possible scope for flexible planning: bathrooms can be prepared for accessibility fit-outs with the load-bearing ViConnect installation element for washbasins and the special fastening elements for handles.



ViCare washbasin

With ceramic handles

412080T2

W 800 x D 550 mm

- Plenty of space under the washbasin for wheelchairs and walking aids
- Adequate knee space for body care in a comfortable seated position
- Integrated handles lend support and help the user to stand up or pull their wheelchair towards the washbasin
- Dirt-repellent and anti-bacterial surface finish
- Generous shelf space all round

Wallway shower tray

Quaryl® shower tray with wall outlet (UDQ 1890 WAL 2V-RW)

Designer cover (UCWAS0341, colour Stone White)

ViConnect wall outlet unit (UCWAS0344)

L 1800 x W 900 x H 20 mm

- Floor-flush and seamless shower area: maximum hygiene and optimum protection against moisture penetration
- Wheel-chair compatible and usable as manoeuvring area
- Anti-slip class C offers maximum safety and the most comfortable walk-in experience
- Side outlet in the wall with subtle designer trim



ViCare UNIVERSAL fold-up shower seat

92174068

W 355 x D 370 mm

- For safety and comfort in the shower
- SoftClosing function for quiet and gentle folding
- TÜV-tested; complies with directive EEC 93/42 for medical devices
- Highly robust, with load-bearing capacity of up to 160 kg
- Seat surface in skin-friendly ABS plastic
- Easy to clean and provides a safe place to sit in a wet environment

A shower toilet offers the highest standards of hygiene and comfort. Users with impaired mobility can attend to their personal care and hygiene free of any restrictions. They maintain their independence.



ViClean-I 100 shower toilet

Rimless

VOE100R1

W 385 x D 595 mm

- Gentle and hygienic cleansing with warm water
- The flush-fit shower nozzle is cleaned automatically
- Rimless DirectFlush toilet with dirt-repellent CeramicPlus surface finish
- Lid with SoftClosing automatic lowering mechanism
- Intuitive operation by remote control or app
- Also ideal for users with restricted motor functions



ViCare DESIGN fold-up support

made of chrome-plated stainless steel

92171861

L 850 mm

- Firm support in sanitary and washing areas
- With soft and easy-to-clean pad
- Load bearing capacity of up to 130 kg, TÜV-tested
- EasyClick mechanism for simple installation and removal
- Suitable for fitting on left- and right-hand side, for added flexibility



ViConnect toilet flush plate 200G ProActive+

with lighting, dual flush

922311RE

W 269 x H 161 x D 13 mm

- Integrated hygienic flush reduces germs
- Flushing activated automatically for hygienic use
- Two-zone sensor detects required volume of flushing water
- LED lighting provides user guidance
- Convenient non-contact flush activation by hand gestures is possible



WE MAKE THINGS EASIER FOR EVERYONE

And that includes you. Investing in accessibility solutions for your properties should pay off for you without entailing any major outlay. To this end, we support you with intelligent system solutions which are easy to install and durable.

Appropriate solutions are available from Villeroy & Boch to address the different requirements relating to accessible bathrooms. As a single-source supplier for the bathroom, we offer all the necessary installation elements and matching bathroom ceramics, tap fittings, flush plates and accessories.

Accessibility always calls for adequate movement areas

Movement areas are a key criterion for an accessible bathroom. Such areas allow a wheelchair or walking frame room for manoeuvre. Washbasins offering sufficient space for positioning a wheelchair underneath or floor-flush showers enable compliance with the stipulated movement areas even in smaller bathrooms. In accessible bathrooms in private homes, these areas may overlap. The mandatory clearances are stipulated in DIN standard 18040-2 (R).



ACCESSIBILITY PAYS OFF FOR EVERYONE

Care facilities are confronted with the challenges of high hygiene requirements, rising cost pressure and the responsible task of caring for elderly people in a duly attentive manner. The ViCare collection for accessible bathrooms from Villeroy & Boch promotes residents' independence and reduces the required scope of cleaning work.

True benefits for staff and residents alike

Caring for the elderly is challenging work in every respect. Every measure that makes the daily routines easier helps to improve job satisfaction among carers and nursing staff. Appropriately planned and fitted-out bathrooms can make a crucial contribution here.

For accessible bathrooms in care facilities, Villeroy & Boch offers ergonomic sanitary ceramics and intelligent products which enable greater independence for people with restricted motor functions. This also relieves the strain on staff. The extended length of our ViCare toilets makes it easier to move from the wheelchair to the toilet, for example – with or without the assistance of carers. Staff and residents alike benefit from the high user-friendliness of our products and the safety which they bring.

We make care easier

This applies equally to care of the sanitary ceramics: with CeramicPlus, our products sport particularly dirt-repellent surfaces which make easier work of cleaning. Flowing forms and a minimal number of joints additionally lessen the required scope of cleaning work – thereby also cutting running costs and reducing workloads.

What are the defining features of a good accessible bathroom at a care facility?

- Adequate movement areas around toilet, washbasin and shower
- Feel-good factor resulting from attractive design and accessories
- Products which are easy and quick to clean
- Handles and supporting features for safety and assurance
- Floor-flush shower with wall-mounted grab bar and seat
- Toilet and washbasin which can be used comfortably with a wheelchair or walking frame



HOME FROM HOME – COURTESY OF VILLEROY & BOCH

Everyone likes a feel-good bathroom. Residents of care homes wish in particular for attractive furnishings which meet their individual needs and allow them a high degree of independence. The timeless design of our ViCare collection enables you to design attractive accessible bathrooms in which everyone will feel at home. ViCare also assures you of the right balance between homeliness and economic viability.

More space for more mobility

Plan sufficient movement areas in accordance with DIN-108040 2(R). This will ensure that wheelchair users can also move around the bathroom in comfort. And that carers have enough space to support them. You will find a concise summary of the relevant standards on pages 18 to 21.



Advantages of ViCare in bathrooms at care facilities

- Durable and robust products
- Smooth and joint-free surfaces for easy-cleaning
- Ergonomic design
- Complies with the EU Medical Device Directive (93/42/EEC)
- Optional dirt-repellent surface finish (CeramicPlus & AntiBac)
- ViCare collection can be installed in accordance with the specifications of the DIN 18040 standard

The easy-care and robust products from Villeroy & Boch keep the required scope of cleaning work low. This relieves the strain on your staff and reduces running costs substantially. Optimum accessibility in the bathroom provides for the greatest possible degree of independence – to the benefit of residents and staff alike.

ViCare washbasin

without overflow
711961R1
W 600 x D 490 mm

The flowing form of the washbasin minimises the risk of injury in case of any inadvertent knocks, and there is plenty of space under the washbasin for wheelchair access. This is also facilitated by the inward curve on the front. The integrated shelf offers plenty of space of hygiene products.



ViCare washdown toilet

Rimless and wall-mounted
4695ROT2
W 360 x D 595 mm

- All toilet seats can withstand loads of up to 240 kg
- Dirt-repellent and anti-bacterial finish
- DirectFlush for a water-saving and thorough flush



ViCare FUNCTION

Shower grab rail
92173168
L 1135 x W 1208 mm

- High-density surfaces for easy cleaning
- Load-bearing capacity of the handle system 20 % higher than specified in the relevant standard
- TÜV tested and CE certified
- Ideal support and attractive design

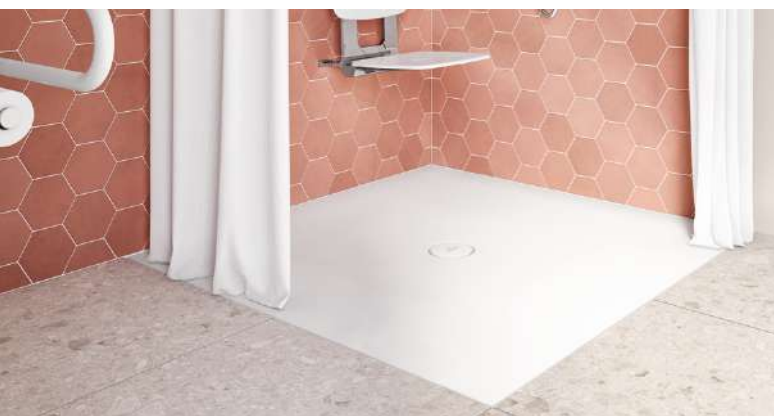

Subway Infinity

Square shower tray
6228J501
W 1000 x D 1000 x H 40mm

- Can be used with a wheelchair and as a movement area
- Easy-care and robust sanitary ceramics
- Dirt-repellent and anti-bacterial finish
- Ultra-flat shower tray which can be cut to size



SMART DESIGN ALL ROUND

Many factors come into play when planning accessible bathrooms in care facilities. Firstly, there is the DIN-108040 2(R) standard, which provides clear specifications for movement areas. For all other requirements with regard to safety, ergonomics and optimum support, Villeroy & Boch offers well-considered design to provide precisely the desired degree of home comfort and convenience.

Elderly people who are not yet in need of care prefer homes for the elderly and assisted living facilities. In such cases, the bathrooms do not need to be fully fitted out for accessibility. Operators should nevertheless think of the future: with our installation systems you can retrofit supports and handles on the toilet or in the shower as and when the need arises. Or you can install an appropriately accessible washbasin, should residents become reliant on a wheelchair at some point in the future.

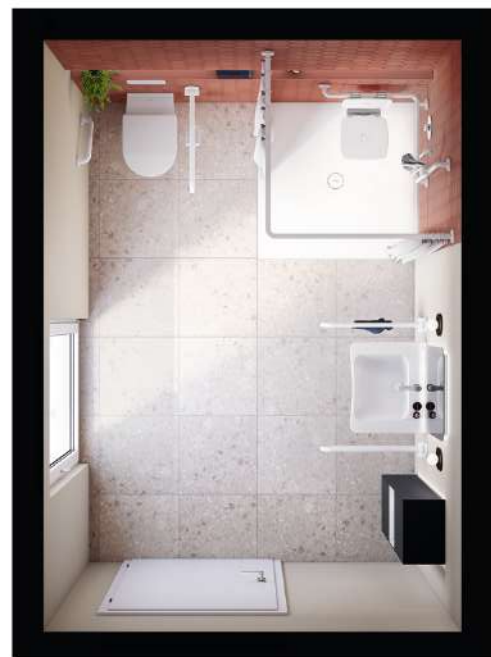



ACCESSIBILITY IS ABOUT MAKING THINGS EASIER

Planning sanitary facilities for public areas is a highly complex matter. The legal requirements pertaining to accessibility are particularly detailed and broad in scope for the public sector. With this in mind, we make everything especially simple – with ViCare.

The ViCare collection from Villeroy & Boch fulfils individual comfort and hygiene requirements in all public areas, from shopping centres and restaurants to swimming baths or citizens' advice bureaus. Our ergonomic and well-conceived system solutions allow you to design accessible sanitary facilities in accordance with all users' needs.

Brand quality with added value

In addition to larger movement areas there is another important factor to be considered: public sanitary facilities are used much more frequently than those in private homes. With this in mind, our solutions meet high standards of robustness and hygiene, thanks to a range of special attributes ranging from high-quality workmanship to special surface finishes which reduce bacterial growth and dirt deposits and simplify cleaning.

More comfort, less costs

Our solutions are designed to offer users more hygiene and comfort while scaling down the required scope of cleaning work for you as an operator. Thanks to the rimless toilet design in the ViCare collection, the entire bowl is flushed without leaving any residues and can be cleaned more efficiently.

What are the distinguishing features of good accessible sanitary facilities in public buildings?

- Supporting handles and an emergency call system are installed
- Hygienic and easy-clean surfaces
- Ergonomic design
- Toilets with longer projections and additional backrests
- Toilets and washbasins which can be used comfortably with a wheelchair



THREE-FOLD CLEANLINESS

The ultimate in toilet hygiene

The combined effects of AntiBac, CeramicPlus and DirectFlush offer even greater toilet hygiene: These ally an anti-bacterial and dirt-repellent surface finish with a thorough and efficient flushing technology which saves water and cleaning agents. This threefold effect has been tested by independent institutes (in accordance with JIS Y 2801:2010). To ensure that visitors always feel comfortable when using your sanitary facilities.

Advantages of our surface finishes

What is CeramicPlus?

- Scratch-resistant and durable glaze
- Causes water to form into droplets and prevents residues from drying on the surface
- Easier to clean, thus requiring less cleaning agent
- Resistant to household acids and alkalis

How does AntiBac work?

- Integrated anti-bacterial effect (silver ions in the glaze)
- Reduces bacterial growth by 99 % in under two hours
- Protection and safety throughout the product's entire lifetime

Choosing the right sanitary ceramics pays off: with Villeroy & Boch you comply with all DIN standards while saving water and cleaning agents and also reducing the scope of cleaning work.

ViCare Washbasin

without overflow

4A686101

W 650 x D 550 mm

The wheelchair-accessible washbasin offers adequate freedom of movement and can be used in a standing or seated position. Ceramic handles are integrated into the sides to make it easier for users to pull their wheelchairs towards the washbasin and to offer firm support when standing. The rounded edges ensure fast and easy cleaning.



ViCare Washdown toilet

Rimless and wall-mounted

4601ROT2

W 360 x D 700 mm

- Extended projection of this toilet facilitates safe and comfortable transfer from the wheelchair
- No slipping of the toilet seat during transfer
- Load-bearing capacity of 240 kg – surpassing the standard requirement of 150 kg
- Lid can be removed for cleaning



ViCare FUNCTION

Fold-up support

92172668

L 850 mm

- Firm and comfortable support
- Maximum load of 130 kg (20 % higher than required by the relevant DIN standard)
- Robust and easy to clean
- Produced in easy-care powder-coated aluminium



ViConnect toilet flush plate 200S

92249068

W 253 x H 145 x D 62 mm

- Water-saving dual flush plate
- Ideal for combination with ViConnect toilet elements





WINNING SOLUTIONS ALL ROUND

Stress and strain, knocks and bumps, frequent cleaning – sanitary facilities in public areas come in for plenty of heavy wear. Fortunately, you can always rely on Villeroy & Boch as your one-stop supplier of durable and economical solutions.

Villeroy & Boch is your prime address for accessible fit-outs of sanitary facilities. We are your single-source supplier for everything you need to fit out public showers, toilets and washrooms in an appealing guise and in compliance with the relevant standards. Our ViCare collection guarantees accessibility to the mandatory standards in sanitary areas.

Strong selling points for ViCare from Villeroy & Boch

- Toilet seats with load capacity of up to 240 kg (German DIN standard requires 150 kg)
- Handle systems able to support load of 130 kg: 20% higher than required for unrestricted wheelchair use
- Hygienic ceramics thanks to AntiBac and CeramicPlus
- Multiple glazing affords protection from knocks



ORIENTATION AND SAFETY

The DIN standard stipulates the structural and layout requirements. Consider these when planning bathrooms for future needs and be sure to err on the side of caution. This way, you can be sure you have taken all aspects into account – especially when difficult layouts are involved.

Essential requirements

Accessible bathrooms are defined first and foremost by adequate freedom of movement and the layout of the furnishings and fittings. They must be fully suitable for use with wheelchairs and walking frames and by people with sensory disabilities.

The most important criteria stipulated in the standard include the following: shower trays must be installed flush with the floor and must have a non-slip surface. The movement areas may overlap. When sub-structures such as extra-long toilets and folding supports are involved, it is to be ensured that the walls are of adequate stability. Where the existing walls are not designed for such sub-structures, it is recommendable to use fastening and installation systems.

The well-conceived system solutions from Villeroy&Boch ensure compliance with all accessibility requirements and open up new design scope.



DIN 18040-2

Private homes

DIN 18040-2	Washbasin area	Toilet area	Shower area
Movement area	120 x 120 cm	120 x 120 cm in front of toilet; 20 cm on either side	120 x 120 cm
Dimensions and installation	Must be usable in a seated position	Individual height and depth	Floor-flush; max. drop 2 cm
Clearances and specific requirements	Legroom required under the washbasin	–	Slip-resistant floor covering min. application group B in accordance with GUV-I 8527
Supports and handles	–	Individual	Individual
Tap fittings and flushing	<ul style="list-style-type: none"> • Single-lever tap fitting recommended • Temperature limiter required in case of non-contact tap fitting 	Any flushing system and backrest may be chosen	<ul style="list-style-type: none"> • Single-lever tap fitting recommended • Temperature limiter required in case of non-contact tap fitting



DIN 18040-2 (R)

Private homes in which wheelchairs are used and care facilities

DIN 18040-2 (R)	Washbasin area	Toilet area	Shower area
Movement area	150 x 150 cm	150 x 150 cm in front of toilet; min. 90 cm on one side and 30 cm on the other	150 x 150 cm
Dimensions and installation	<ul style="list-style-type: none"> • Max. front edge height 80 cm • Min. wheelchair clearance 55 cm 	<ul style="list-style-type: none"> • Height 46 to 48 cm above floor • Min. depth 70 cm 	Floor-flush; max. drop 2 cm
Clearances and specific requirements	<ul style="list-style-type: none"> • Knee space of 67 cm measured up to 30 cm behind front edge • Width of wheelchair space under washbasin 90 cm; axial 	<ul style="list-style-type: none"> • Backrest 55 cm behind front edge of toilet • Toilet lid not suitable as sole backrest 	Non-slip floor-covering min. assessment group B in compliance with GUV-I 8527
Supports and handles	–	<ul style="list-style-type: none"> • To right and left of toilet • Height 28 cm above seat • At least 15 cm longer than front edge of toilet 	<ul style="list-style-type: none"> • Retrofit option for seat • Seat height 46 to 48 cm
Tap fitting and flushing system	<ul style="list-style-type: none"> • Single-lever tap fitting recommended • Temperature limiter required in case of non-contact tap fitting 	Flush and toilet roll holder: single-handed operation, accessible without altering seated position	<ul style="list-style-type: none"> • Single-lever tap fitting recommended • Temperature limiter required in case of non-contact tap fitting



DIN 18040-1

Public areas

DIN 18040-1	Washbasin area	Toilet area	Shower area
Movement area	150 x 150 cm	150 x 150 cm in front of toilet; min. 90 cm on both sides	150 x 150 cm
Dimensions and installation	<ul style="list-style-type: none"> • Max. front edge height 80 cm • Min. wheelchair clearance 55 cm 	<ul style="list-style-type: none"> • Height 46 to 48 cm above floor • Min. depth 70 cm 	Floor-flush; max. drop 2 cm
Clearances and specific requirements	<ul style="list-style-type: none"> • Knee space of 67 cm measured up to 30 cm behind front edge • Width of wheelchair space under washbasin 90 cm; axial 	<ul style="list-style-type: none"> • Backrest 55 cm behind front edge of toilet • Toilet lid not suitable as sole backrest • Emergency call system close to toilet; reachable in seated and lying position 	Non-slip floor-covering min. assessment group B in compliance with GUV-I 8527
Supports and handles	–	<ul style="list-style-type: none"> • To right and left of toilet • Height 28 cm above seat; extending at least 15 cm beyond toilet • At least 15 cm longer than front edge of toilet 	<ul style="list-style-type: none"> • Folding seat fitted • Horizontal and vertical handles installed at height of 85 cm above floor
Tap fitting and flushing system	<ul style="list-style-type: none"> • Single-lever tap fitting or non-contact tap • Temperature limiter required in case of non-contact tap fitting 	Flush and toilet roll holder: single-handed operation, accessible without altering seated position	<ul style="list-style-type: none"> • Single-lever shower fitting with hand-held shower head • Temperature limiter required in case of non-contact tap fitting



PRODUCT OVERVIEW

Concise and complete: acquaint yourself with the full details of our product range for accessible bathrooms.

KEY TO SYMBOLS



ANTIBAC:
99,9% LESS
BACTERIAL GROWTH



QUARYL®:
EXCLUSIVE DESIGNS THAT ARE
PLEASANT TO THE TOUCH



ANTISLIP:
SLIP-RESISTANT,
NON-POROUS AND HYGIENIC



QUICKRELEASE:
REMOVABLE TOILET SEAT
FACILITATES CLEANING
TOILET SEAT



CERAMICPLUS:
SPECIAL SURFACE FINISH
WITH BEADING EFFECT



SOFTCLOSING:
TOILET SEAT CLOSES
SOFTLY AND SILENTLY



DIRECTFLUSH:
RIMLESS DESIGN,
SPOTLESS CLEANLINESS



TITANCERAM:
EXCEPTIONAL
TRENGTH



EASYCLEAN:
IDEAL AND EASY
CLEANING



TWISTFLUSH:
CLEANS TOILET WITH THE
POWER OF SWIRLING WATER



ONELEVEL:
A UNIFORM APPEARANCE
FOR THE FLOOR



AVAILABILITY GUARANTEE:
EXTENDED WARRANTY
PROVIDES SECURE BASIS
FOR PLANNING



PROACTIVEPLUS:
NON-CONTACT FLUSHING FOR ADDED
HYGIENE AND SUSTAINABILITY

○ Suitable for 1-hole tap fitting, tap hole punched through

1x ○ ○ Suitable for 1-hole tap fitting, left tap hole punched through, right tap hole pre-punched

○ With overflow

1x ○ ○ Suitable for 1-hole tap fitting, right tap hole punched through, left tap hole pre-punched

⊗ Without overflow

⊗ Without overflow (tap holes left and right pre-punched)

○ ○ ○ Suitable for 3-hole tap fittings, central tap hole punched through

VICONNECT COLLECTION

Ideal for every room scenario: our installation elements for simple installation of all sanitary items and supports.



VICONNECT INSTALLATION SYSTEMS
WASHBASIN INSTALLATION ELEMENT,
FOR DRY-WALL CONSTRUCTION,
525 x 1120 x 75 mm

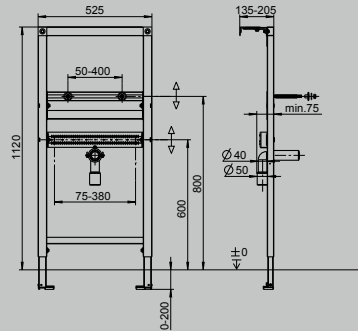

ART NO.:	WIDTH	HEIGHT	DEPTH	WEIGHT
92214900	525 mm	1120 mm	75 mm	8,05 kg



VICONNECT INSTALLATION SYSTEMS
TOILET INSTALLATION ELEMENT, FOR
DRY-WALL CONSTRUCTION,
525 x 1120 x 135 mm

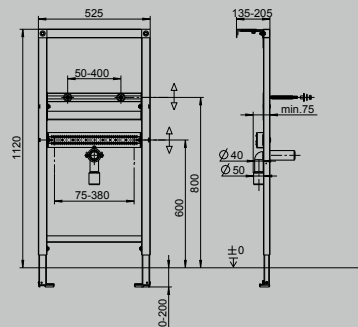

ART NO.:	WIDTH	HEIGHT	DEPTH	WEIGHT
92242700	525 mm	1120 mm	135 mm	15,8 kg



VICONNECT INSTALLATION SYSTEMS
TOILET FLUSH PLATE 200G PROACTIVE+,
WITH LIGHTING, DUAL FLUSH

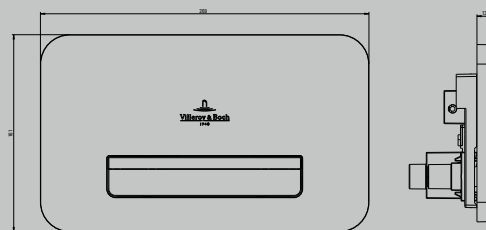

ART NO.:	WIDTH	HEIGHT	DEPTH	WEIGHT
922311XX	269 mm	161 mm	13 mm	0,7 kg

Glass Glossy White RE
 Stainless steel LC





VICONNECT INSTALLATION SYSTEMS
TOILET FLUSH PLATE 200G, DUAL FLUSH

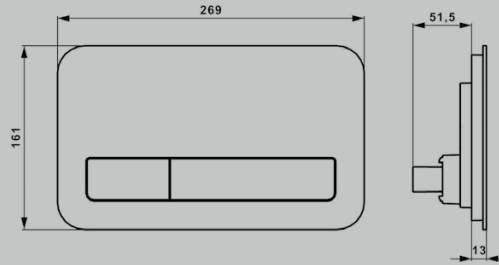

ART NO.:	WIDTH	HEIGHT	DEPTH	WEIGHT
922400XX	269 mm	161 mm	13 mm	0,6 kg



Glass Glossy White
RE



Glass Glossy Grey
RA



Glass Glossy Black
RB



VICONNECT INSTALLATION SYSTEMS
TOILET FLUSH PLATE 22S, DUAL FLUSH

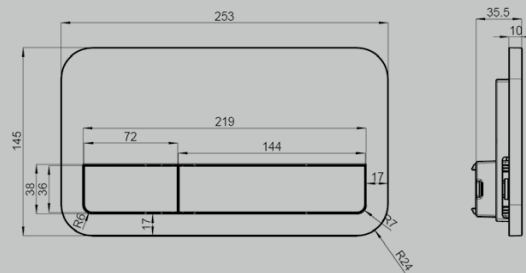

ART NO.:	WIDTH	HEIGHT	DEPTH	WEIGHT
922490XX	253 mm	145 mm	10 mm	0,37 kg



White
68



Black Matt
AN



Brushed Chrome
69



Chrome
61



OTHER FLUSH PLATE MODELS
ARE AVAILABLE



VICONNECT INSTALLATION SYSTEMS
FASTENING ELEMENTS FOR HANDLES,
294 x 1120 x 48 mm

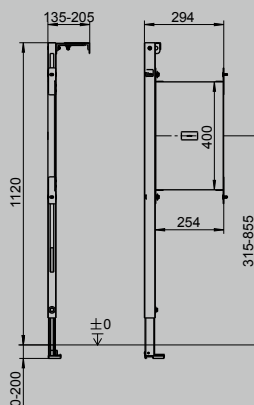

ART NO.:	WIDTH	HEIGHT	DEPTH	WEIGHT
92198300	294 mm	1120 mm	48 mm	5,35 kg



VICONNECT INSTALLATION SYSTEMS
FASTENING ELEMENTS FOR HANDLES,
294 x 1120 x 48 mm

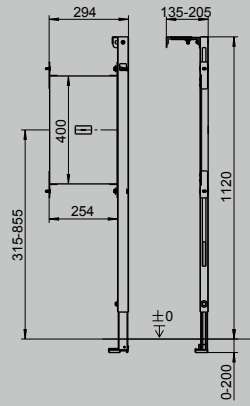

ART NO.:	WIDTH	HEIGHT	DEPTH	WEIGHT
92210900	294 mm	1120 mm	48 mm	5,35 kg

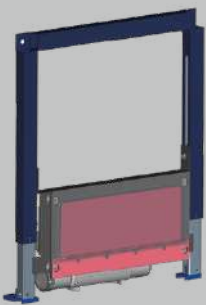

VICONNECT INSTALLATION SYSTEMS
WALL OUTLET UNIT INCL. FRAME FOR DRY-WALL
CONSTRUCTION, 525 x 510 x 135 mm

ART NO.:	WIDTH	HEIGHT	DEPTH
UCWAS0343	525 mm	510 mm	135 mm

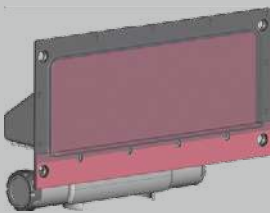

VICONNECT INSTALLATION SYSTEMS
WALL OUTLET UNIT FOR
BRICK-WALL CONSTRUCTION,
403x 256 x 133 mm

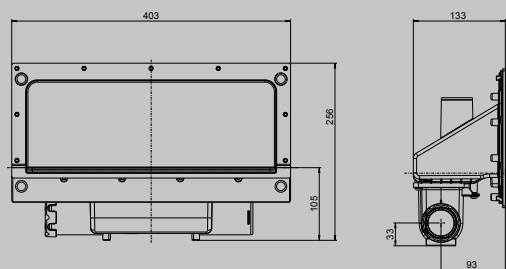

ART NO.:	WIDTH	HEIGHT	DEPTH
UCWAS0344	403 mm	256 mm	133 mm

VICARE COLLECTION

Here you will find appropriate solutions for all DIN-18040 specifications



Washbasin installation element
92214900

VICARE WASHBASIN
RECTANGULAR, CENTRAL TAP HOLE
PUNCHED THROUGH, WITH OVERFLOW

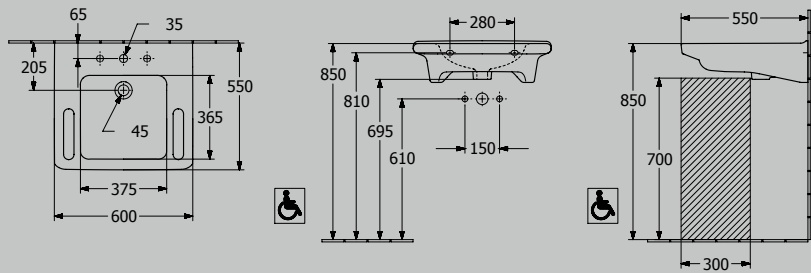

ART NO.:	WIDTH	DEPTH	TAP HOLE	OVERFLOW	WEIGHT
4A6860XX	600 mm	550 mm			19 kg
4A6880XX	800 mm	550 mm			24 kg

White Alpin 01 White Alpin CeramicPlus R1 White Alpin AntiBac CeramicPlus T2

VICARE WASHBASIN
RECTANGULAR, CENTRAL TAP HOLE
PUNCHED THROUGH,
WITHOUT OVERFLOW

ART NO.:	WIDTH	DEPTH	TAP HOLE	OVERFLOW	WEIGHT
4A6861XX	600 mm	550 mm			19 kg
4A6881XX	800 mm	550 mm			24 kg

White Alpin 01 White Alpin CeramicPlus R1 White Alpin AntiBac CeramicPlus T2

VICARE WASHBASIN
RECTANGULAR, WITHOUT TAP HOLE,
WITH OVERFLOW

ART NO.:	WIDTH	DEPTH	TAP HOLE	OVERFLOW	WEIGHT
4A6862XX	600 mm	550 mm			19 kg
4A6882XX	800 mm	550 mm			24 kg

White Alpin 01 White Alpin CeramicPlus R1 White Alpin AntiBac CeramicPlus T2

VICARE WASHBASIN
RECTANGULAR, WITHOUT TAP HOLE,
WITHOUT OVERFLOW

ART NO.:	WIDTH	DEPTH	TAP HOLE	OVERFLOW	WEIGHT
4A6863XX	600 mm	550 mm			19 kg
4A6883XX	800 mm	550 mm			24 kg

White Alpin 01 White Alpin CeramicPlus R1 White Alpin AntiBac CeramicPlus T2



Washbasin installation element
92214900

VICARE WASHBASIN
RECTANGULAR, CENTRAL TAP HOLE
PUNCHED THROUGH, WITH OVERFLOW

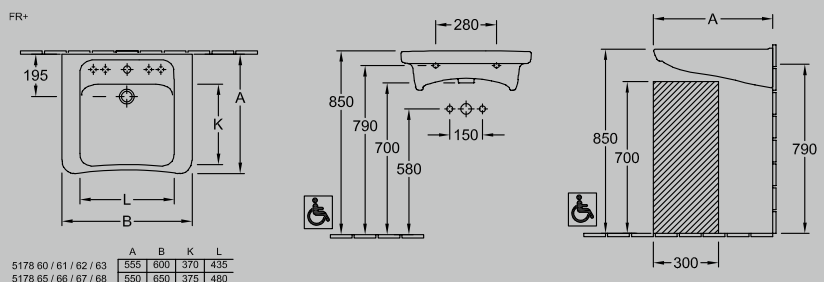

	A	B	K	L
5178 60 / 61 / 62 / 63	555	600	370	435
5178 65 / 66 / 67 / 68	550	650	375	480

ART NO.:	WIDTH	DEPTH	TAP HOLE	OVERFLOW	WEIGHT
517867XX	650 mm	550 mm			20,85 kg

White Alpin 01 White Alpin CeramicPlus R1 White Alpin AntiBac CeramicPlus T2

VICARE WASHBASIN
RECTANGULAR, CENTRAL TAP HOLE
PUNCHED THROUGH,
WITHOUT OVERFLOW

ART NO.:	WIDTH	DEPTH	TAP HOLE	OVERFLOW	WEIGHT
517868XX	650 mm	550 mm			21 kg

White Alpin 01 White Alpin CeramicPlus R1 White Alpin AntiBac CeramicPlus T2



Washbasin installation element
92214900

VICARE WASHBASIN

OVAL, SUITABLE FOR 3-HOLE TAP FITTING, CENTRAL TAP HOLE PUNCHED THROUGH, WITH OVERFLOW

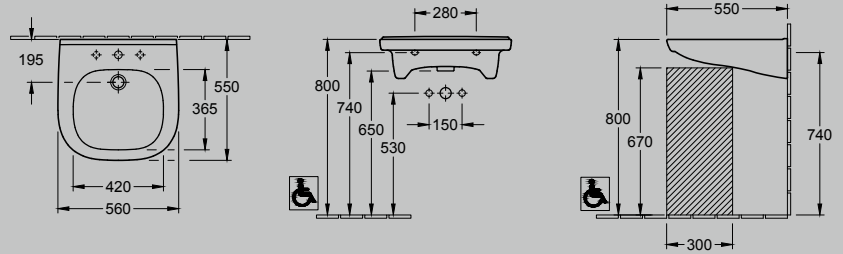

ART NO.:	WIDTH	DEPTH	TAP HOLE	OVERFLOW	WEIGHT
411955XX	560 mm	550 mm			17 kg



White Alpin
01



White Alpin CeramicPlus
R1



White Alpin AntiBac CeramicPlus
T2

ART NO.:	WIDTH	DEPTH	TAP HOLE	OVERFLOW	WEIGHT
411960XX	610 mm	550 mm			18,8 kg



White Alpin
01



White Alpin CeramicPlus
R1



White Alpin AntiBac CeramicPlus
T2

ART NO.:	WIDTH	DEPTH	TAP HOLE	OVERFLOW	WEIGHT
411956XX	560 mm	550 mm			17 kg



White Alpin
01



White Alpin CeramicPlus
R1



White Alpin AntiBac CeramicPlus
T2

ART NO.:	WIDTH	DEPTH	TAP HOLE	OVERFLOW	WEIGHT
411961XX	610 mm	550 mm			18,8 kg



White Alpin
01



White Alpin CeramicPlus
R1



White Alpin AntiBac CeramicPlus
T2



Washbasin installation element
92214900

VICARE WASHBASIN

OVAL, SUITABLE FOR 3-HOLE TAP FITTING, CENTRAL TAP HOLE PUNCHED THROUGH, WITH OVERFLOW

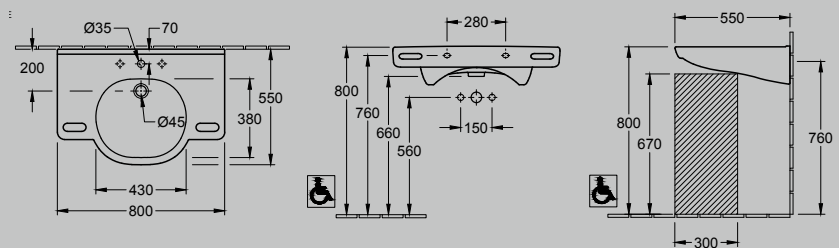

ART NO.:	WIDTH	DEPTH	TAP HOLE	OVERFLOW	WEIGHT
412080XX	800 mm	550 mm			21,6 kg



White Alpin
01



White Alpin CeramicPlus
R1



White Alpin AntiBac CeramicPlus
T2

ART NO.:	WIDTH	DEPTH	TAP HOLE	OVERFLOW	WEIGHT
412081XX	800 mm	550 mm			21,6 kg



White Alpin
01



White Alpin CeramicPlus
R1

VICARE WASHBASIN

OVAL, SUITABLE FOR 3-HOLE TAP FITTING, CENTRAL TAP HOLE PUNCHED THROUGH, WITHOUT OVERFLOW

Note: Washbasins without overflow are mandatory in the health and healthcare segment in accordance with the relevant DIN standards.



Washbasin installation element
92214900

VICARE WASHBASIN

RECTANGULAR, SUITABLE FOR 3-HOLE TAP FITTING, CENTRAL TAP HOLE PUNCHED THROUGH, WITH OVERFLOW

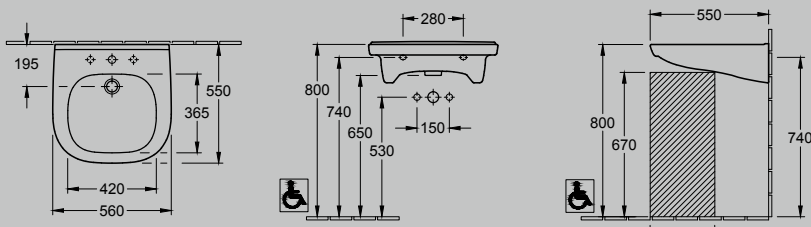

ART NO.:	WIDTH	DEPTH	TAP HOLE	OVERFLOW	WEIGHT
711963XX	600 mm	490 mm			18,56 kg



White Alpin CeramicPlus R1

VICARE WASHBASIN

RECTANGULAR, SUITABLE FOR 3-HOLE TAP FITTING, CENTRAL TAP HOLE PUNCHED THROUGH, WITHOUT OVERFLOW

ART NO.:	WIDTH	DEPTH	TAP HOLE	OVERFLOW	WEIGHT
711961XX	600 mm	490 mm			17,86 kg



White Alpin CeramicPlus R1



Toilet installation system
92242700

VICARE WASHDOWN TOILET RIMLESS

WALL-MOUNTED, HORIZONTAL OUTLET, NOT SUITABLE FOR INSTALLATION WITH FLUSH VALVES

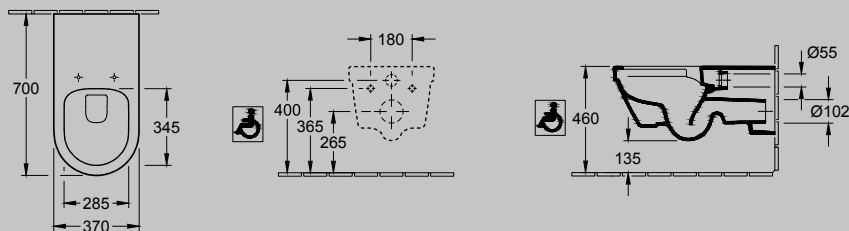

ART NO.:	WIDTH	DEPTH	WEIGHT
5649R0XX	370 mm	700 mm	31 kg



White Alpin CeramicPlus R1



White Alpin AntiBac CeramicPlus T2



Toilet installation system
92242700

VICARE WASHDOWN TOILET RIMLESS
WALL-MOUNTED, WITHOUT FASTENING HOLES FOR TOILET SEAT, HORIZONTAL OUTLET, NOT SUITABLE FOR INSTALLATION WITH FLUSH VALVES

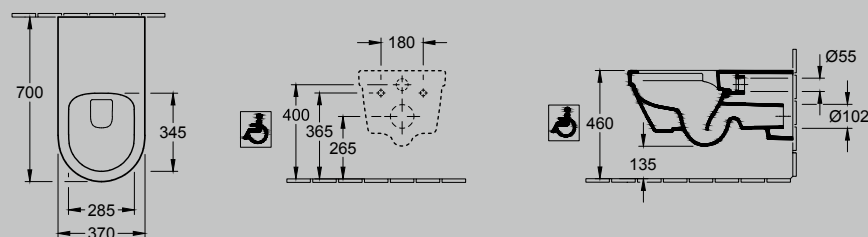

ART NO.:	WIDTH	DEPTH	WEIGHT
5649R2XX	370 mm	700 mm	31 kg

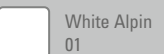

White Alpin CeramicPlus R1



White Alpin AntiBac CeramicPlus T2



Toilet installation system
92242700

VICARE WASHDOWN TOILET RIMLESS
WALL-MOUNTED, HORIZONTAL OUTLET,
NOT SUITABLE FOR INSTALLATION WITH
FLUSH VALVES

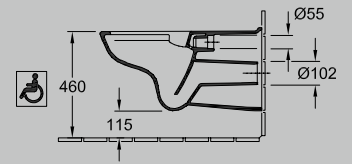
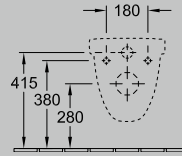
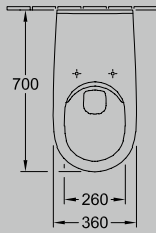

ART NO.:	WIDTH	DEPTH	WEIGHT
4601R0XX	360 mm	700 mm	22 kg



White Alpin
01



White Alpin CeramicPlus
R1



White Alpin AntiBac CeramicPlus
T2



Toilet installation system
92242700

VICARE WASHDOWN TOILET RIMLESS
WALL-MOUNTED, WITHOUT FASTENING
HOLES FOR TOILET SEAT, HORIZONTAL
OUTLET, NOT SUITABLE FOR INSTALLATION
WITH FLUSH VALVES

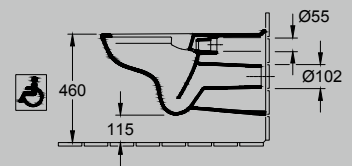
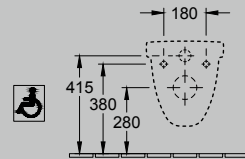
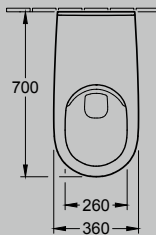

ART NO.:	WIDTH	DEPTH	WEIGHT
4601R2XX	360 mm	700 mm	22 kg



White Alpin
01



White Alpin CeramicPlus
R1



VICARE WASHDOWN TOILET RIMLESS
FOR FLOOR-STANDING CLOSE-COUPLED
SUITE, HORIZONTAL OUTLET

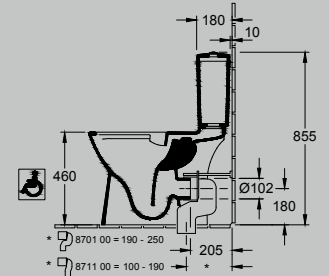
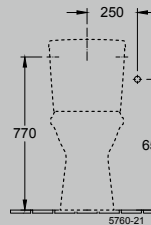
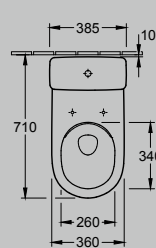

ART NO.:	WIDTH	DEPTH	WEIGHT
4620R0XX	360 mm	710 mm	28,7 kg



White Alpin
01



White Alpin CeramicPlus
R1



White Alpin AntiBac CeramicPlus
T2



Toilet installation system
92242700

VICARE WASHDOWN TOILET RIMLESS
WALL-MOUNTED, HORIZONTAL OUTLET,
NOT SUITABLE FOR INSTALLATION WITH
FLUSH VALVES

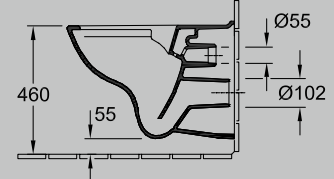
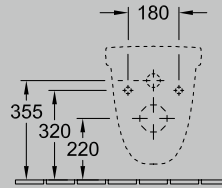
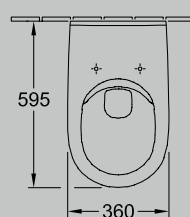

ART NO.:	WIDTH	DEPTH	WEIGHT
4695R0XX	360 mm	595 mm	22 kg



White Alpin
01



White Alpin CeramicPlus
R1



White Alpin AntiBac CeramicPlus
T2



WASHDOWN TOILET RIMLESS
FLOOR-STANDING, HORIZONTAL OUTLET

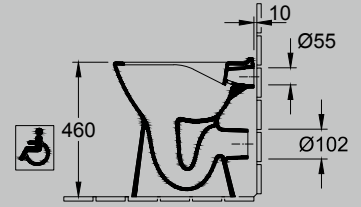
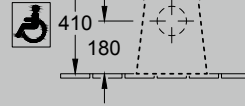
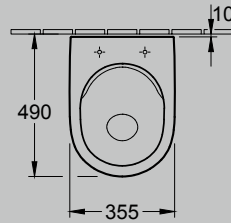

ART NO.:	WIDTH	DEPTH	WEIGHT
4683R0XX	355 mm	480 mm	18,7 kg



White Alpin
01



White Alpin CeramicPlus
R1

WASHOUT TOILET RIMLESS
FLOOR-STANDING, HORIZONTAL OUTLET



ART NO.:	WIDTH	DEPTH	WEIGHT
4684R0XX	355 mm	490 mm	19,5 kg



White Alpin
01



White Alpin CeramicPlus
R1



VICARE TOILET SEAT
WITH SPECIAL BUFFERS TO PREVENT
SLIPPING TO THE SIDES,
WITH QUICKRELEASE AND
SOFTCLOSING FEATURE
STAINLESS-STEEL HINGES

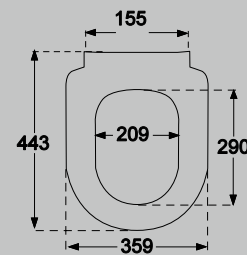

ART NO.:	WIDTH	DEPTH	WEIGHT
9M51B101	359 mm	443 mm	3,8 kg



VICARE TOILET SEAT
WITH SPECIAL BUFFERS TO PREVENT
SLIPPING TO THE SIDES,
WITH EASY-GRIP LID, OVAL,
WITH CONTINUOUS HINGE BOLT,
STAINLESS-STEEL HINGES



ART NO.:	WIDTH	DEPTH	WEIGHT
9M67S1XX	369 mm	459 mm	3,1 kg



White Alpin AntiBac
01



Blue AntiBac
P1

VICARE TOILET SEAT
FASTENING FROM ABOVE, WITH
SPECIAL BUFFERS TO PREVENT
SLIPPING TO THE SIDES, WITH EASY-GRIP LID,
WITH QUICKRELEASE AND SOFTCLOSING
FEATURE, STAINLESS-STEEL HINGES



ART NO.:	WIDTH	DEPTH	WEIGHT
9M6761XX	369 mm	459 mm	3,1 kg



White Alpin
01

VICARE TOILET SEAT
WITH SPECIAL BUFFERS TO PREVENT
SLIPPING TO THE SIDES, WITH GROOVE
AROUND COVER, OVAL, WITH CONTINUOUS
HINGE BOLT, STAINLESS-STEEL HINGES

ART NO.:	WIDTH	DEPTH	WEIGHT
9M7261XX	369 mm	459 mm	3,2 kg



White Alpin AntiBac
01



Blue AntiBac
P1



VICARE SEAT
WITH SPECIAL BUFFERS TO PREVENT
SLIPPING TO THE SIDES,
WITH CONTINUOUS HINGE BOLT,
STAINLESS-STEEL HINGES

ART NO.:	WIDTH	DEPTH	WEIGHT
9M9761XX	353 mm	422 mm	1,39 kg

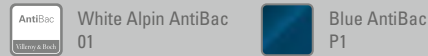

VICARE SEAT
STAINLESS-STEEL HINGES

ART NO.:	WIDTH	DEPTH	WEIGHT
9M7161XX	354 mm	438 mm	1,04 kg



VICARE DESIGN

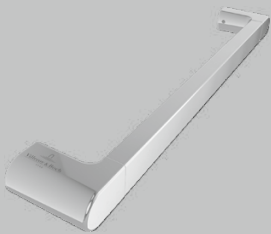

VICARE DESIGN WALL-MOUNTED GRAB BAR
MADE OF CHROME-PLATED ALUMINIUM
WITH ZINC DIE-CAST CONNECTING PARTS,
CAN BE ATTACHED BOTH VERTICALLY AND
HORIZONTALLY

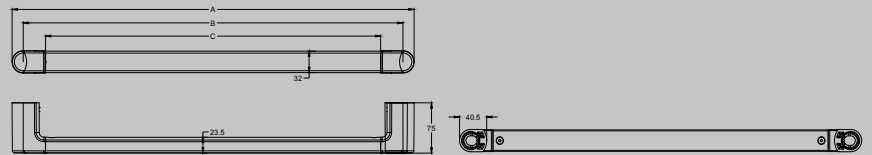

ART NO.:	LENGTH	WEIGHT
92170861	400 mm	1,2 kg
92170961	600 mm	1,1 kg

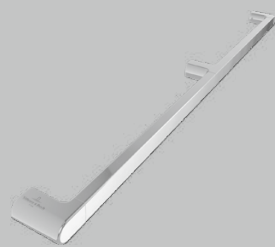

VICARE DESIGN WANDGRAB RAIL
MADE OF CHROME-PLATED ALUMINIUM
WITH ZINC DIE-CAST CONNECTING PARTS,
CAN BE ATTACHED BOTH VERTICALLY AND
HORIZONTALLY

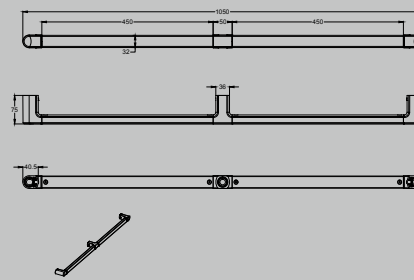

ART NO.:	LENGTH	WEIGHT
92171061	1050 mm	1,9 kg

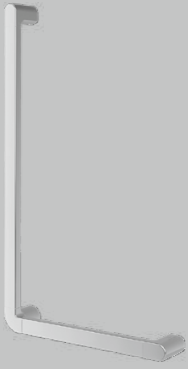

VICARE DESIGN WALL-MOUNTED GRAB BAR
MADE OF CHROME-PLATED ALUMINIUM
WITH ZINC DIE-CAST CONNECTING PARTS,
90° REVERSIBLE

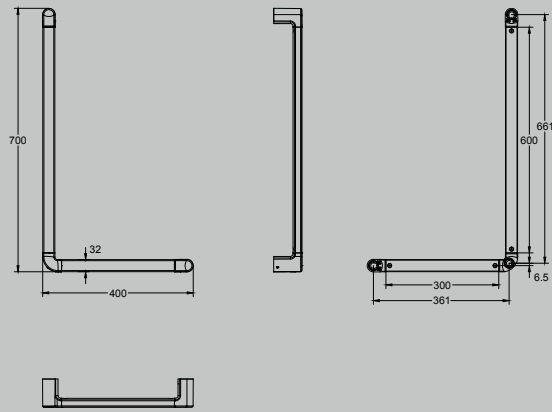

ART NO.:	LENGTH	WIDTH	WEIGHT
92171161	700 mm	400 mm	2 kg

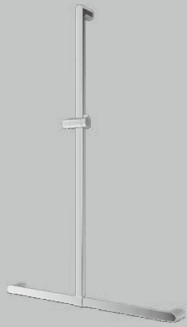

VICARE DESIGN GRAB RAIL
MADE OF CHROME-PLATED ALUMINIUM
WITH ZINC DIE-CAST CONNECTING PARTS,
T-SHAPED WITH SHOWER HOLDER

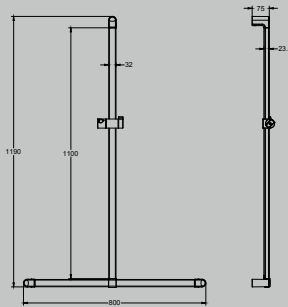

ART NO.:	LENGTH	WIDTH	WEIGHT
92171461	1190 mm	800 mm	2,6 kg



VICARE DESIGN SHOWER GRAB RAIL
VERTICAL, MADE OF CHROME-PLATED
ALUMINIUM WITH ZINC DIE-CAST
CONNECTING PARTS

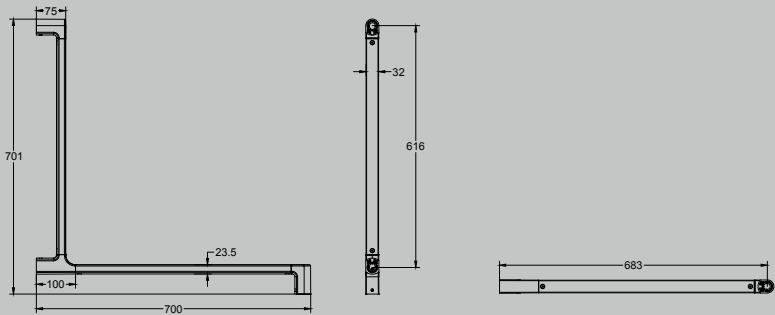

ART NO.:	LENGTH	WEIGHT
92171561	700 mm	2,1 kg



VICARE DESIGN HANDLES
SHOWER RAIL MADE OF CHROME-
PLATED ALUMINIUM WITH ZINC DIE-CAST
CONNECTING PARTS

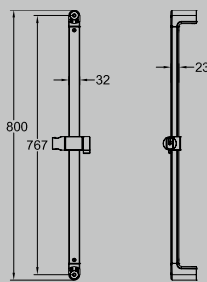

ART NO.:	LENGTH	WEIGHT
92171361	800 mm	1,2 kg

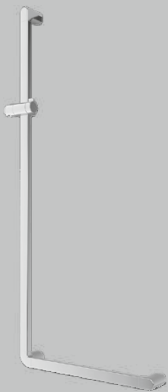

VICARE DESIGN SHOWER HOLDER
MADE OF CHROME-PLATED ALUMINIUM
WITH ZINC DIE-CAST CONNECTING PARTS,
REVERSIBLE

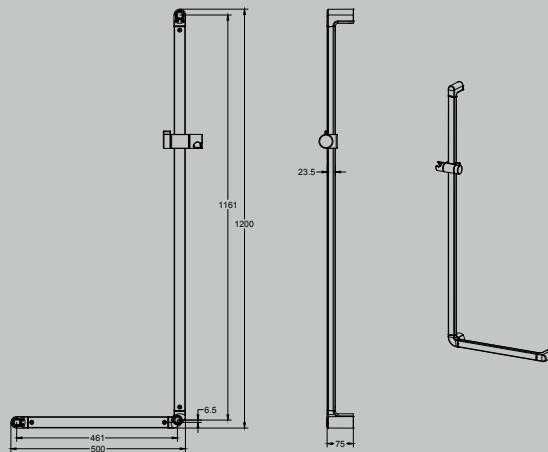

ART NO.:	LENGTH	WIDTH	WEIGHT
92171261	1200 mm	500 mm	2,6 kg



 FASTENING ELEMENTS FOR HANDLES
92210900 / 92198300

VICARE DESIGN FOLD-UP SUPPORT
MADE OF CHROME-PLATED STAINLESS STEEL

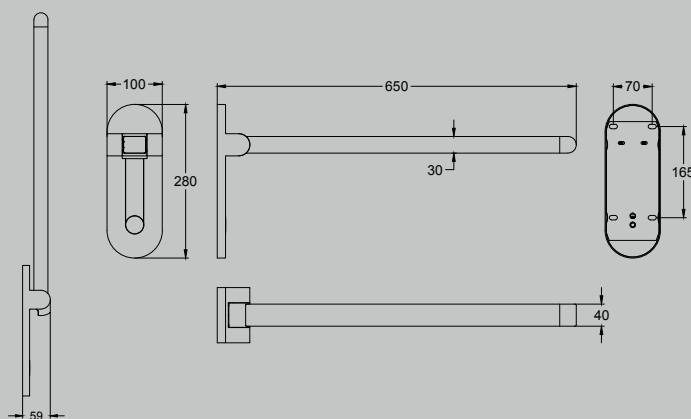

ART NO.:	LENGTH	WEIGHT
92171961	650 mm	3,4 kg

VICARE DESIGN FOLD-UP SUPPORT
MADE OF CHROME-PLATED STAINLESS STEEL,
WITH EASYCLICK RELEASE MECHANISM

ART NO.:	LENGTH	WEIGHT
92174161	650 mm	3,4 kg

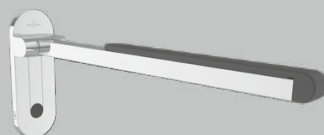

 FASTENING ELEMENTS FOR HANDLES
92210900 / 92198300

VICARE DESIGN FOLD-UP SUPPORT
MADE OF CHROME-PLATED STAINLESS STEEL,
WITH "SOFTTOUCH" PAD AND "EASYCLICK"
RELEASE MECHANISM

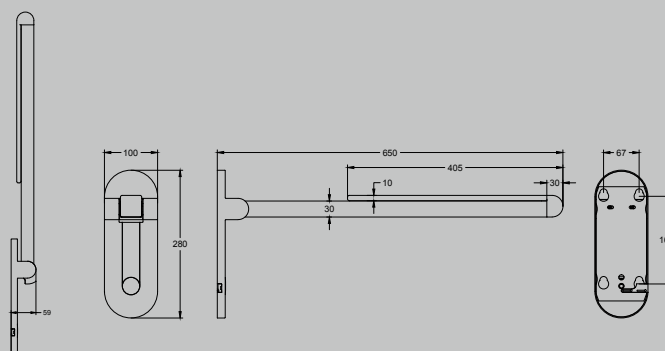

ART NO.:	LENGTH	WEIGHT
92171661	650 mm	3,4 kg

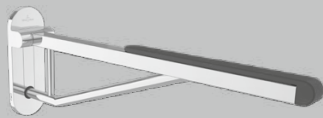

FASTENING ELEMENTS FOR HANDLES
92210900 / 92198300

VICARE DESIGN FOLD-UP SUPPORT

MADE OF CHROME-PLATED STAINLESS STEEL, THE HANDLES, 750 mm AND 850 mm, ARE SUPPORTED BY A STAINLESS STEEL TUBE, DIAMETER 25 mm, WITH "SOFTTOUCH" PAD AND "EASYCLICK" RELEASE MECHANISM

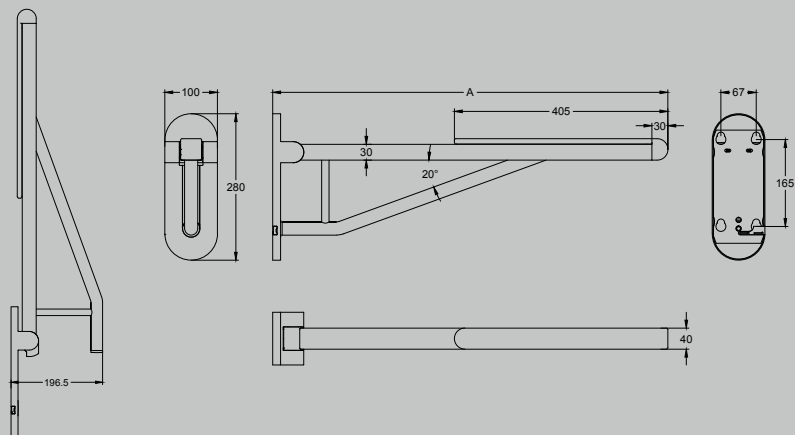

ART NO.:	LENGTH	WEIGHT
92171761	750 mm	4,4 kg
92171861	850 mm	5,4 kg

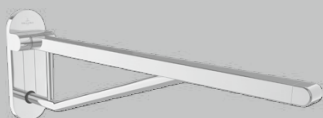

FASTENING ELEMENTS FOR HANDLES
92210900 / 92198300

VICARE DESIGN FOLD-UP SUPPORT

MADE OF CHROME-PLATED STAINLESS STEEL, THE HANDLES, 750 mm AND 850 mm, ARE SUPPORTED BY A STAINLESS STEEL TUBE, DIAMETER 25 mm

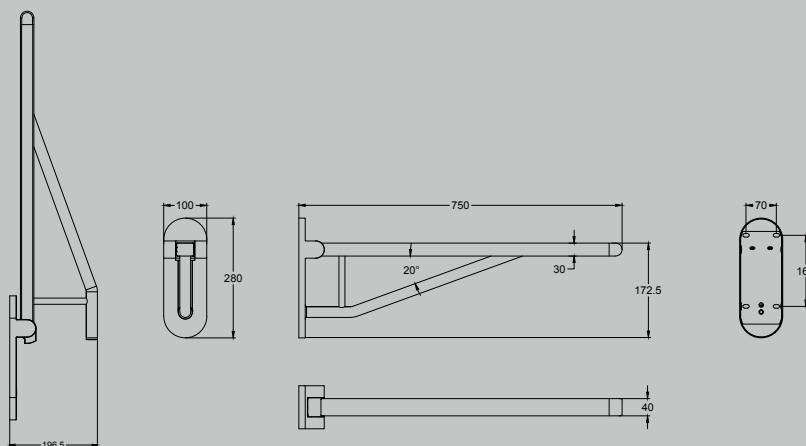

ART NO.:	LENGTH	WEIGHT
92172061	750 mm	4,4 kg
92172161	850 mm	5,4 kg

VICARE DESIGN FOLD-UP SUPPORT

MADE OF CHROME-PLATED STAINLESS STEEL, THE HANDLES, 750 mm AND 850 mm, ARE SUPPORTED BY A STAINLESS STEEL TUBE, DIAMETER 25 mm, WITH "EASYCLICK" RELEASE MECHANISM

ART NO.:	LENGTH	WEIGHT
92174261	750 mm	4,4 kg
92174361	850 mm	5,4 kg



VICARE SHELF

ABS-PLASTIC SHELF FOR "DESIGN" AND "FUNCTION" GRAB BAR SYSTEMS

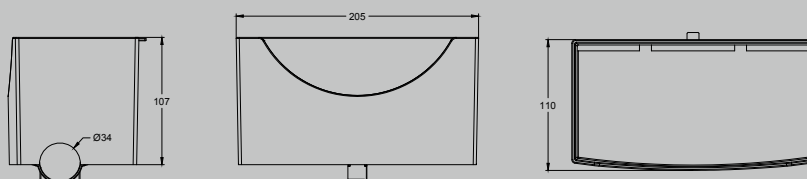

ART NO.:	WIDTH	HEIGHT	DEPTH	WEIGHT
92173268	205 mm	107 mm	110 mm	0,5 kg

VICARE FUNCTION



VICARE FUNCTION WALL-MOUNTED GRAB BAR
MADE OF POWDER-COATED ALUMINIUM,
CAN BE ATTACHED BOTH VERTICALLY AND
HORIZONTALLY TUBE DIAMETER 32 mm

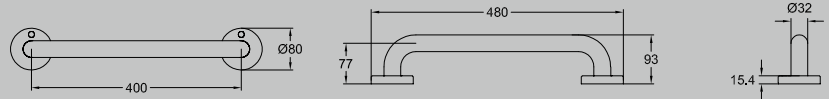

ART NO.:	LENGTH	WEIGHT
92172268	400 mm	0,6 kg
92172368	600 mm	0,8 kg

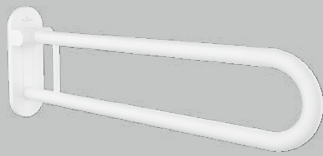

FASTENING ELEMENTS FOR HANDLES
92210900 / 92198300

VICARE FUNCTION FOLD-UP SUPPORT
MADE OF POWDER-COATED ALUMINIUM

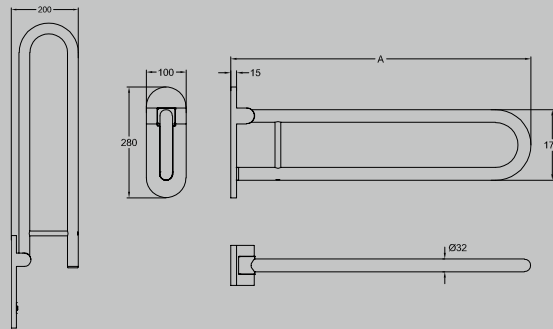

ART NO.:	LENGTH	WEIGHT
92172468	650 mm	3 kg
92172568	750 mm	3,4 kg
92172668	850 mm	3,9 kg

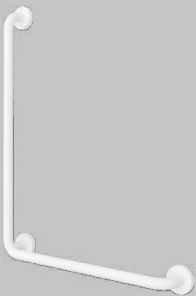

VICARE FUNCTION WALL-MOUNTED GRAB BAR
90° REVERSIBLE,
MADE OF POWDER-COATED ALUMINIUM

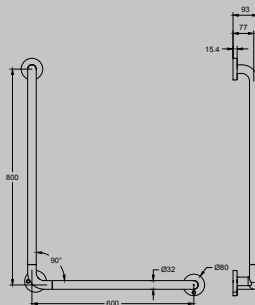

ART NO.:	LENGTH	WIDTH	WEIGHT
92172768	800 mm	600 mm	1,6 kg



VICARE FUNCTION WALL-MOUNTED GRAB BAR WITH SHOWER HOLDER
90°, MADE OF POWDER-COATED ALUMINIUM,
90° REVERSIBLE

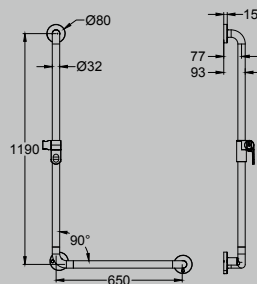

ART NO.:	LENGTH	WIDTH	WEIGHT
92172868	1190 mm	650 mm	2,3 kg



VICARE FUNCTION WALL-MOUNTED GRAB BAR WITH SHOWER HOLDER
MADE OF POWDER-COATED ALUMINIUM, VERTICAL WITH SHOWER HOLDER, SHOWER CAN BE ADJUSTED IN HEIGHT WITH ONE HAND

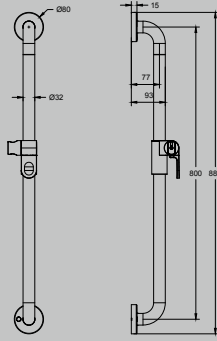

ART NO.:	LENGTH	WEIGHT
92172968	800 mm	1,1 kg

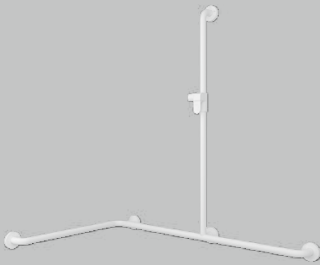

VICARE FUNCTION DUSCHGRAB RAIL WITH SHOWER HOLDER
IN T-FORM, MADE OF POWDER-COATED ALUMINIUM, WITH VERTICAL AND HORIZONTAL HANDLE, SHOWER CAN BE ADJUSTED IN HEIGHT WITH ONE HAND

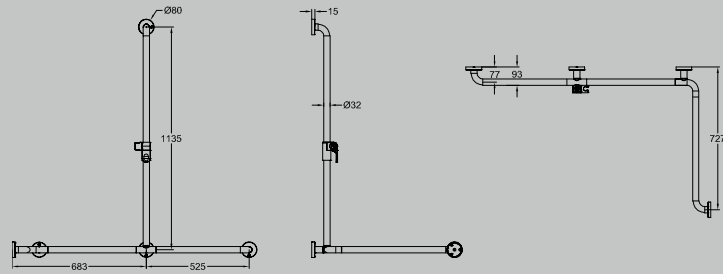

ART NO.:	LENGTH	WIDTH	WEIGHT
92173168	1135 mm	1208 mm	2,5 kg

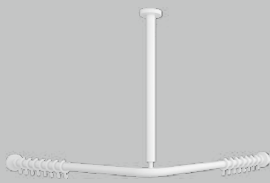

VICARE FUNCTION DUSCHSTANGE
MADE OF POWDER-COATED ALUMINIUM, FOR CURTAIN, FOR USE IN CORNER (WITHOUT CURTAIN), RAILS CAN BE SHORTENED

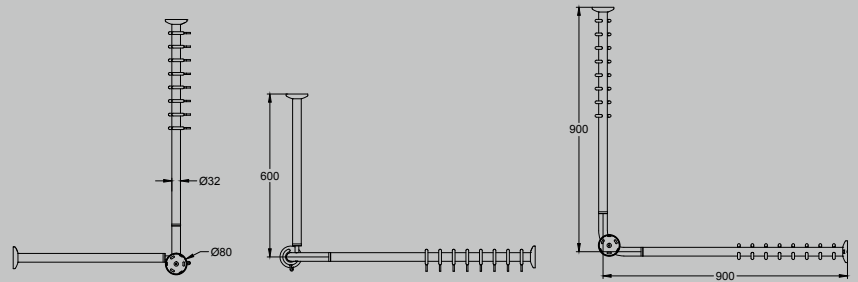

ART NO.:	LENGTH	WIDTH	WEIGHT
92170568	900 mm	900 mm	2,3 kg
92170668	1000 mm	1000 mm	2,8 kg
92170768	1200 mm	1200 mm	3,2 kg

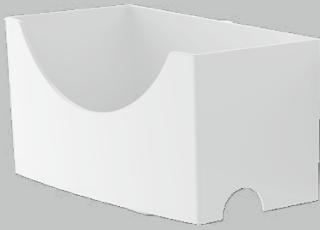

VICARE FUNCTION SHELF

SHELF MADE OF ABS PLASTIC FOR FUNCTION GRAB BAR SYSTEM, TUBE DIAMETER 32-34 mm

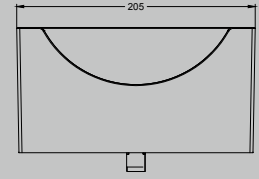
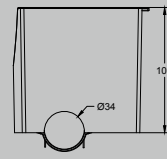
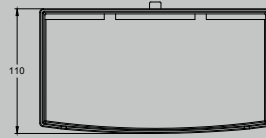

ART NO.:	WIDTH	HEIGHT	DEPTH	WEIGHT
92173368	205 mm	107 mm	110 mm	0,5 kg

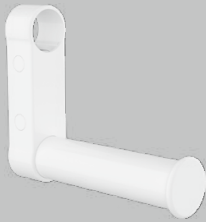

VICARE FUNCTION PAPIERROLLENHALTER

MADE OF POWDER-COATED ALUMINIUM, FOR FUNCTION FOLD-UP SUPPORTS, FOR ATTACHING TO GRAB BAR SYSTEMS WITH A DIAMETER OF 32mm

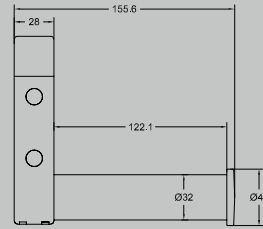
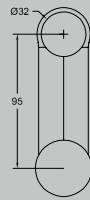

ART NO.:	LENGTH	HEIGHT	WEIGHT
92173068	150 mm	115 mm	0,2 kg

VICARE UNIVERSAL



VICARE UNIVERSAL HANGING SEAT
MADE OF ALUMINIUM WITH ABS-PLASTIC SEAT, ADJUSTABLE IN HEIGHT BY 4 cm, FITS ALL GRAB BAR SYSTEMS WITH A MAXIMUM DIAMETER OF 34 mm, MAXIMUM LOAD 160 kg IN COMPLIANCE WITH TÜV REQUIREMENTS

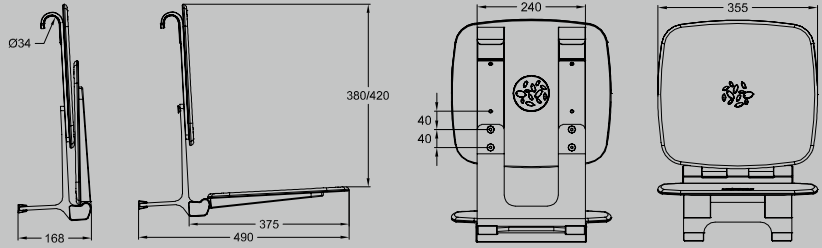

ART NO.:	WIDTH	DEPTH	HEIGHT	WEIGHT
92170168	355 mm	390 mm	420 mm	5,8 kg



VICARE UNIVERSAL FOLD-UP SHOWER SEAT
MADE OF ALUMINIUM WITH ABS-PLASTIC SEAT, WITH SOFTSTOP FEATURE, MAXIMUM LOAD 160 kg IN COMPLIANCE WITH TÜV REQUIREMENTS

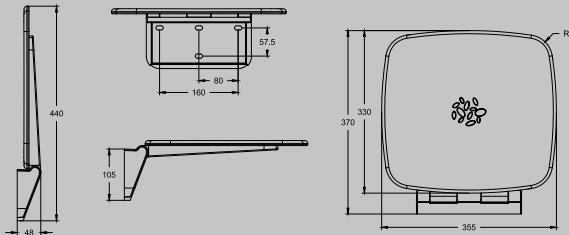

ART NO.:	WIDTH	DEPTH	HEIGHT	WEIGHT
92170268	355 mm	370 mm	105 mm	2,7 kg

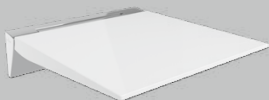

VICARE UNIVERSAL FOLD-UP SHOWER SEAT
MADE OF ALUMINIUM WITH ABS-PLASTIC SEAT, WITH SOFTSTOP FEATURE, MAXIMUM LOAD 160 kg IN COMPLIANCE WITH TÜV REQUIREMENTS, WATER DRAINS AWAY

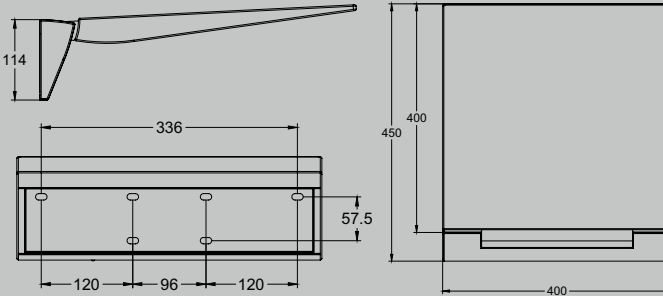

ART NO.:	WIDTH	DEPTH	WEIGHT
92170368	400 mm	450 mm	4,7 kg
92174068	355 mm	370 mm	4,2 kg



VICARE UNIVERSAL BATHROOM STOOL
MADE OF ALUMINIUM WITH ABS-PLASTIC SEAT, MAXIMUM LOAD 160 kg IN COMPLIANCE WITH TÜV REQUIREMENTS

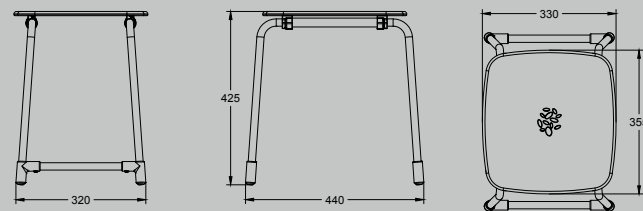

ART NO.:	WIDTH	DEPTH	HEIGHT	WEIGHT
92170468	440 mm	330 mm	425 mm	2,6 kg

VICARE COMBI-PACKS



VICARE COMBI-PACK
WALL-MOUNTED, WASHDOWN TOILET
DIRECTFLUSH 4601 R0 XX,
FOLD-UP SUPPORT FUNCTION 9217 26 68
(2x), HORIZONTAL OUTLET

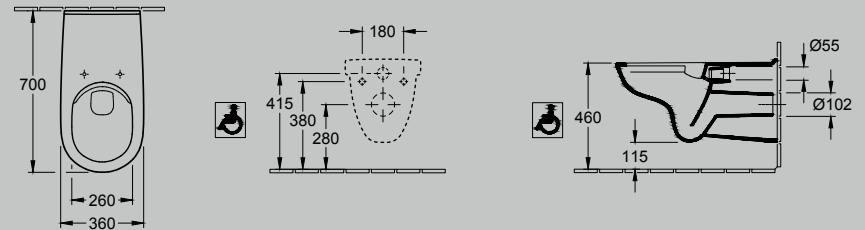

ART NO.:	WIDTH	DEPTH	WEIGHT
46018201	360 mm	700 mm	25,9 kg



VICARE COMBI-PACK
WALL-MOUNTED, WASHDOWN TOILET
DIRECTFLUSH 5649 R0 XX,
FOLD-UP SUPPORT DESIGN 9217 21 61 (2x),
HORIZONTAL OUTLET

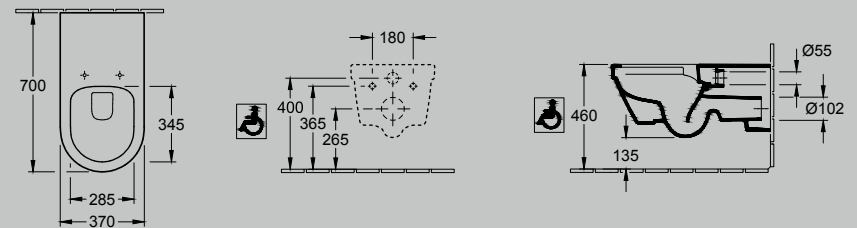

ART NO.:	WIDTH	DEPTH	WEIGHT
56498101	370 mm	700 mm	31 kg



VICARE COMBI-PACK
WALL-MOUNTED, WASHDOWN TOILET,
DIRECTFLUSH 4695 R0 XX, TOILET SEAT
9M67 S1 T1 WITH SPECIAL BUFFERS TO
PREVENT SHIFTING TO THE SIDES,
WITH EASY-GRIP LID,
WITH QUICKRELEASE AND
SOFTCLOSING FEATURE,
DESIGN FOLD-UP SUPPORT 9217 20 61 (2x)

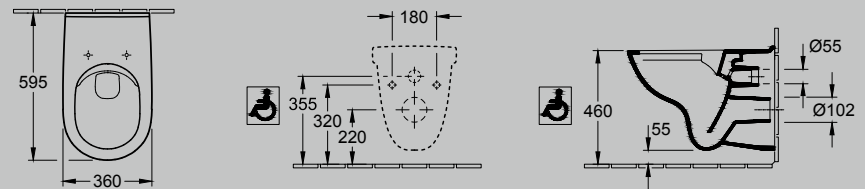

ART NO.:	WIDTH	DEPTH	WEIGHT
46957501	360 mm	595 mm	29,5 kg



VICARE COMBI-PACK
WALL-MOUNTED, WASHDOWN TOILET,
DIRECTFLUSH 4695 R0 XX, TOILET SEAT
9M67 S1 T1 WITH SPECIAL BUFFERS TO
PREVENT SHIFTING TO THE SIDES,
WITH EASY-GRIP LID, WITH
QUICKRELEASE AND SOFTCLOSING
FEATURE, FUNCTION FOLD-UP SUPPORT
9217 25 68 (2x)

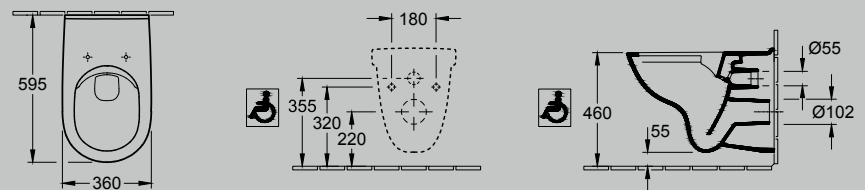

ART NO.:	WIDTH	DEPTH	WEIGHT
46957601	360 mm	595 mm	28,5 kg

SHOWER TRAYS

Floor-flush shower trays for added safety, freedom of movement and comfort.

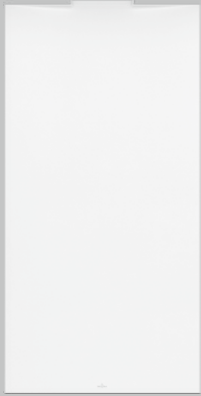

WALLWAY 180 x 90 cm

FLUSH-FITTING SHOWER TRAY MADE OF QUARYL® WITH OUTLET IN THE WALL. FLUSH-FITTING INSTALLATION IN COMBINATION WITH VICONNECT. ANTI-SLIP CLASS C (IN ACCORDANCE WITH DIN-51097). SEALING BY TILER DIRECTLY ON SCREED FLOORING.

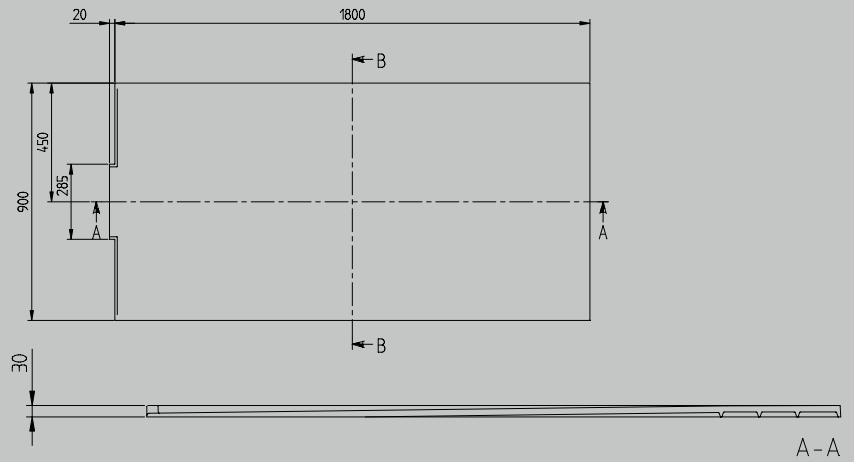

ART NO.:	LENGTH	WIDTH	HEIGHT	WEIGHT
UDQ 1890 WAL 2V-XX	1800 mm	900 mm	20 mm	35 kg
UDQ 1212 WAL 1V-XX	1200 mm	1200 mm	20 mm	31 kg
UDQ 1010 WAL 1V-XX	1000 mm	1000 mm	20 mm	22 kg
UDQ 9090 WAL 1V-XX	900 mm	900 mm	20 mm	17 kg
UDQ 1210 WAL 2BV-XX	1200 mm	1000 mm	20 mm	25 kg
UDQ 1790 WAL 2BV-XX	1700 mm	900 mm	20 mm	33 kg
UDQ 1690 WAL 2BV-XX	1600 mm	900 mm	20 mm	31 kg
UDQ 1590 WAL 2BV-XX	1500 mm	900 mm	20 mm	29 kg
UDQ 1490 WAL 2V-XX	1400 mm	900 mm	20 mm	27 kg
UDQ 1290 WAL 2BV-XX	1200 mm	900 mm	20 mm	23 kg
UDQ 1090 WAL 2BV-XX	1000 mm	900 mm	20 mm	19 kg



Stone White
RW



Anthracite
1S

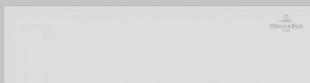

DESIGNER TRIM WALL OUTLET COVER

ART NO.:	LENGTH	WIDTH	HEIGHT
UCWAS0341-XX	320 mm	73 mm	70 mm



Stone White
RW



Brushed Chrome
69



Anthracite
1S

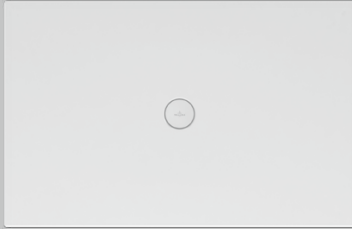

SUBWAY INFINITY

CERAMIC SHOWER TRAY IN WHITE ALPIN, ANTI-SLIP CLASS B (PN 18), 4 SIDES GLAZED. THIS SHOWER TRAY IS NOT CUT AND CAN BE USED FOR ALL INSTALLATION TYPES. THE SHOWER TRAY HAS STEPLESS ACCESS.

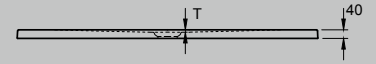
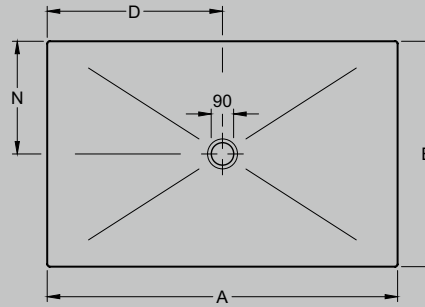

ART NO.:	LENGTH	WIDTH	HEIGHT	WEIGHT
6228J5XX	1000 mm	1000 mm	40 mm	40,85 kg
6230N4XX	1200 mm	900 mm	40 mm	42,95 kg
6231S4XX	1400 mm	900 mm	40 mm	52,8 kg
623245XX	1600 mm	1000 mm	40 mm	63,5 kg

White Alpin
6228J501



AVAILABLE IN FURTHER SIZES



SQUARO INFINITY

QUARYL® SHOWER TRAY, LONG CUT SIDE AGAINST THE WALL, FOR ALL INSTALLATION TYPES

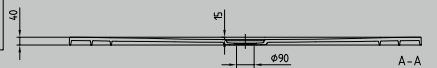
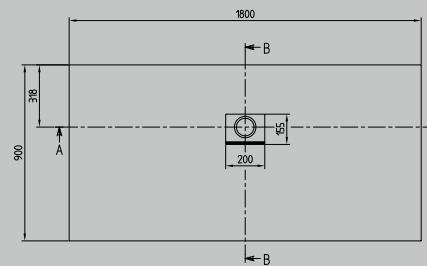

ART NO.:	LENGTH	WIDTH	HEIGHT	WEIGHT
UDQ1890SQI2BV-RW	1800 mm	900 mm	40 mm	46,4 kg
UDQ1210SQI2BV-RW	1200 mm	1000 mm	40 mm	18,6 kg
UDQ1212SQI1V-RW	1200 mm	1200 mm	40 mm	39,4 kg



AVAILABLE IN FURTHER SIZES

TAPS & FITTINGS

Ergonomic and stylish tap fittings – easy to use in any position.



SUBWAY 3.0
SINGLE-LEVER WASHBASIN MIXER
IN CHROME, SINGLE LEVER MIXER
FOR WASHBASINS

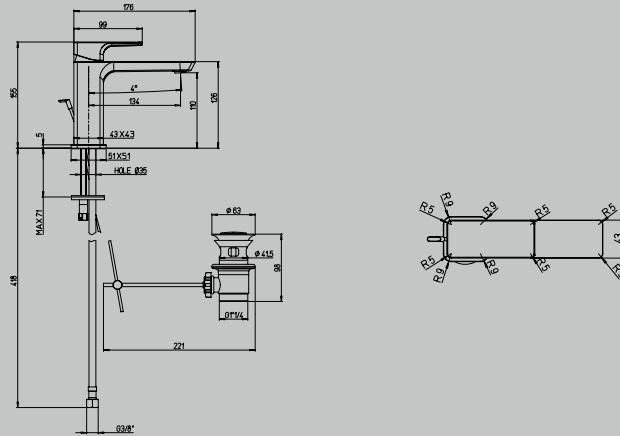

ART NO.:	LENGTH	WIDTH	HEIGHT	WEIGHT
TVW112002000-XX	176 mm	43 mm	155 mm	1,8 kg



SUBWAY 3.0
CONCEALED SINGLE-LEVER MIXER
CONCEALED SHOWER MIXER

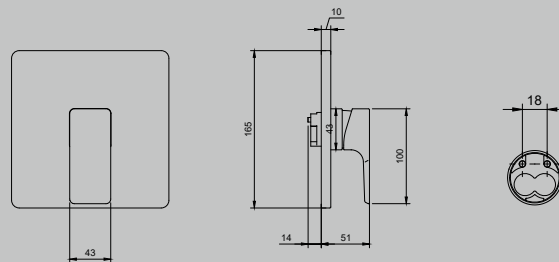

ART NO.:	WIDTH	HEIGHT	WEIGHT
TVS112002000-XX	165 mm	165 mm	1,4 kg



UNIVERSAL SHOWER HOSE
SHOWER HOSE 160 cm

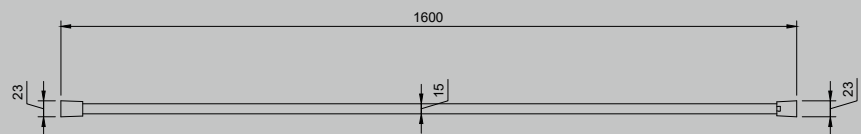

ART NO.:	LENGTH	WEIGHT
TVC000034000-XX	1600 mm	0,285 kg





EMBRACE PLUS HAND-HELD SHOWER
WITH 3 SPRAY TYPES
HAND-HELD SHOWER

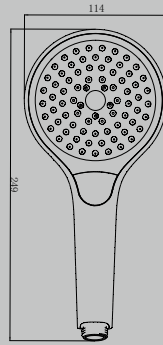

ART NO.:	LENGTH	WIDTH	WEIGHT
TVS109001000-XX	246 mm	114 mm	0,26 kg



Chrome
61



Matt black
K5



Brushed Nickel
64



Brushed gold
76



ARCHITECTURA
SINGLE-LEVER BASIN MIXER
FOR WASHBASIN

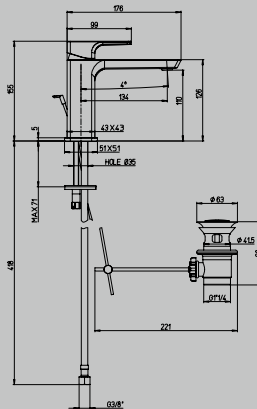

ART NO.:	LENGTH	WIDTH	HEIGHT	WEIGHT
TWV10300400061	164 mm	50 mm	161 mm	1,498 kg



ARCHITECTURA
CONCEALED SINGLE-LEVER MIXER
CONCEALED SHOWER MIXER

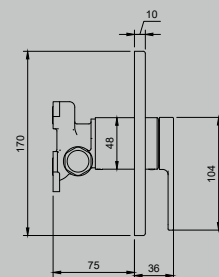
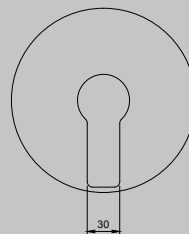
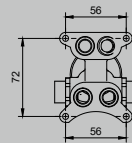

ART NO.:	LENGTH	WEIGHT
TVS103352000-XX	170 mm	1,2 kg



UNIVERSAL THERMOSTAT
SHOWER THERMOSTAT

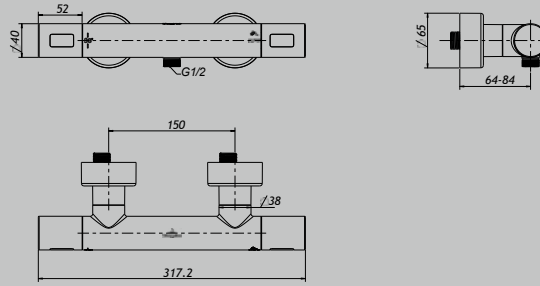

ART NO.:	LENGTH	HEIGHT	WEIGHT
TVS00001700061	317,2 mm	65 mm	1,7 kg



WALL-CONNECTION FITTING
WALL-MOUNTED

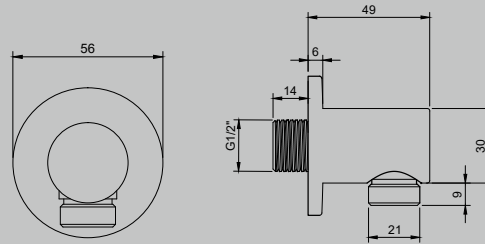

ART NO.:	LENGTH	HEIGHT	WEIGHT
TVC000456000-XX	79 mm	56 mm	0,20 kg



Chrome
61



Matt black
K5



Brushed Nickel
64



Brushed gold
76



O.NOVO
SINGLE-LEVER WASHBASIN MIXER
SINGLE-LEVER MIXER FOR WASHBASINS

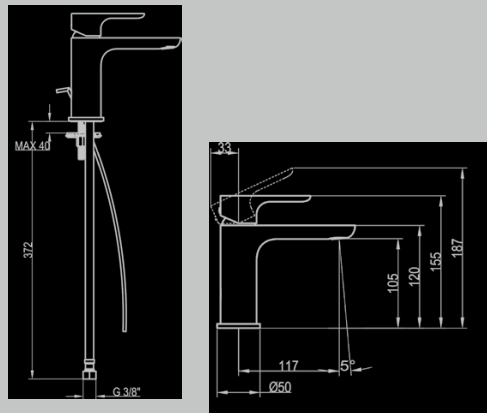

ART NO.:	WIDTH	HEIGHT	WEIGHT
TVW10410111061	50 mm	155 mm	1,685 kg



NON-CLOSING VALVE
 SPARE-PART: NON-CLOSING VALVE,
 75 x 110 x 75 mm WHITE ALPIN

ART NO.:	LENGTH	WIDTH	HEIGHT	WEIGHT
68080001	110 mm	75 mm	75 mm	0,33 kg



HAND-HELD SHOWER

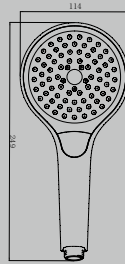

ART NO.:	LENGTH	WIDTH
TVS10900100061	249 mm	114 mm

BATHROOM FURNITURE

The perfect complement: items to match our ViCare collection.



FINION SIDE CABINET
WITH LIGHTING 1 DOOR,
418 x 936 x 270 mm

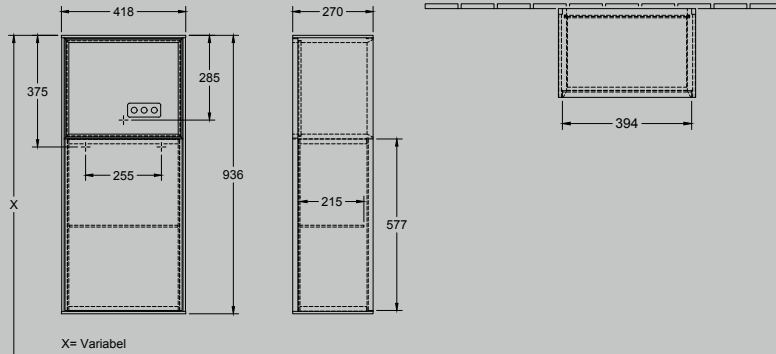

ART NO.:	LENGTH	WIDTH	HEIGHT	WEIGHT
G51	270 mm	418 mm	936 mm	20 kg

-  White Matt MT
-  Glossy White GF
-  Silky Grey HJ
-  Oak Veneer PC
-  Walnut Veneer GN
-  Olive Matt GM
-  Anthracite Matt GK
-  Midnight Blue Matt HG
-  Black Matt PD
-  Gold Matt HF
-  Further colours available



FINION TALL CABINET
WITH LIGHTING 2 DOORS,
418 x 1516 x 270 mm

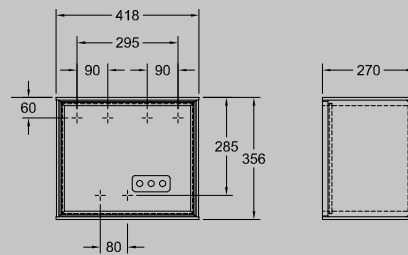

ART NO.:	LENGTH	WIDTH	HEIGHT	WEIGHT
G46	270 mm	418 mm	1516 mm	31 kg

-  White Matt MT
-  Glossy White GF
-  Silky Grey HJ
-  Oak Veneer PC
-  Walnut Veneer GN
-  Olive Matt GM
-  Anthracite Matt GK
-  Midnight Blue Matt HG
-  Black Matt PD
-  Gold Matt HF
-  Further colours available

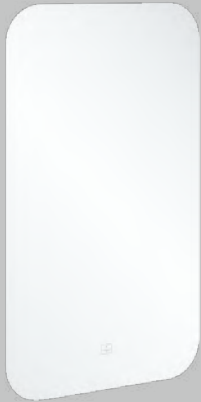

MORE TO SEE LITE MIRROR
WITH LIGHTING,
600 x 1000 x 24 mm

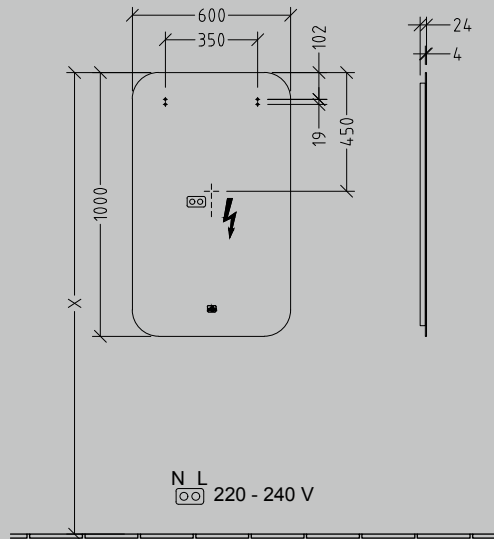

ART NO.:	WIDTH	HEIGHT	DEPTH	WEIGHT
A4611000	600 mm	1000 mm	24 mm	7,5 kg

SUBWAY 3.0 VANITY WASHBASIN



SUBWAY 3.0 VANITY WASHBASIN
800 x 470 x 165 mm

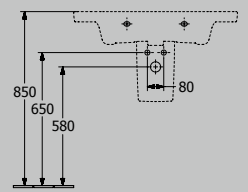
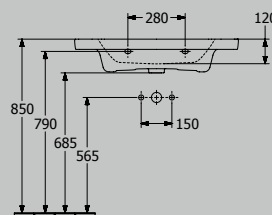
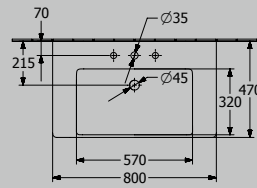

ART NO.:	LENGTH	WIDTH	HEIGHT	WEIGHT
4A7081XX	470 mm	800 mm	165 mm	23,5 kg



White Alpin
01



Stone White
RW



White Alpin CeramicPlus
R1

SHOWER TOILET

The alternative to meet the highest requirements with regard to hygiene and user-friendliness.



VICLEAN SHOWER TOILET RIMLESS
WHITE ALPIN, CERAMICPLUS

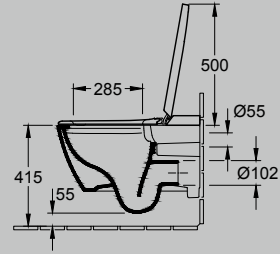
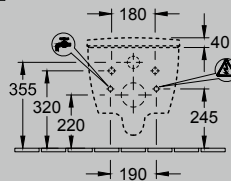
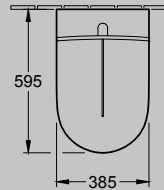

ART NO.:	LENGTH	WIDTH	WEIGHT
V0E100XX	385 mm	595 mm	31,55 kg



White Alpin CeramicPlus
R1



Glossy Black
S0

PROJECTS

The complete concept

Villeroy&Boch works with architects, planners, investors and operators during and after the project – from the first draft to the final version. The modular PROJECTS system from Villeroy&Boch comprises collections and products for individual project requirements with clear segmentation in terms of pricing and subject matter.

The system offer:

- Diverse products for all project requirements
- Wide range of services
- Modern tools for efficient project design
- Newly defined standards for quality, design and innovation
- Rapid and simple orientation through different price and project segments

Project segments:



Hotels & gastronomy



Housing



Office & Commercial



Sport & Culture



Health & Healthcare



Public Sector & Education

You will find further information, services and references for Villeroy&Boch PROJECTS at: pro.villeroy-boch.com

EVERYTHING FOR YOUR PROJECT

3D data service

Bring your interior design creations to life with authentic details. Download the 3D models of our products from the BIM database free of charge. Simple select the appropriate file format for your software.



Scan now!

We will be pleased to advise you!

Further content of relevance to accessibility in the bathroom is also available on our new website:

- Detailed information on our hygiene solutions
- A comprehensive range of documents such as technical drawings, 3D data and other tools for your planning
- Reference projects carried out in the health & healthcare sector



Scan now!

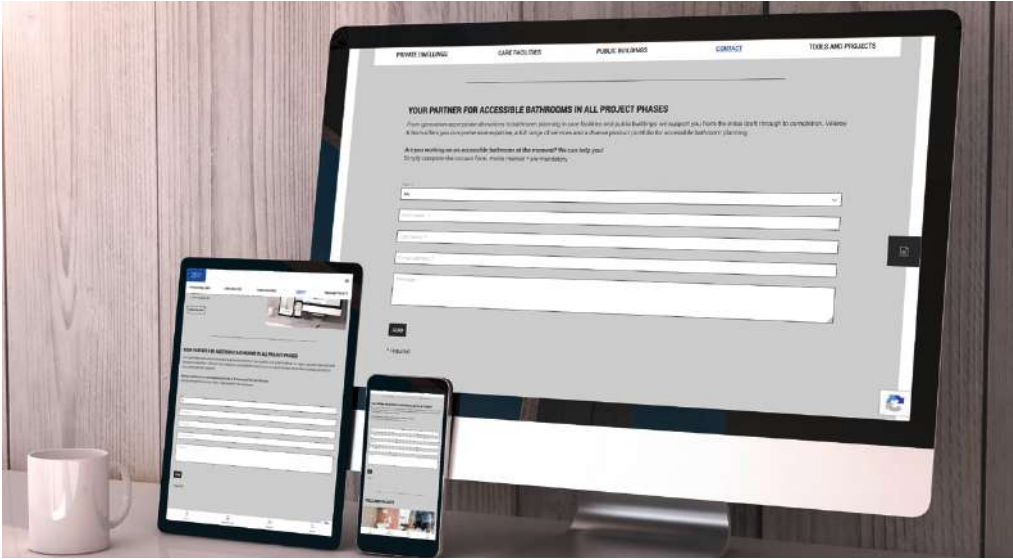

PROJECTS

GERMANY
Villeroy & Boch AG
Bathroom and Wellness Division
Head Office
D-66693 Mettlach
Tel. +49 (0) 68 64-81-0
Fax +49 (0) 68 64-81-1484
info.bad@villeroy-boch.com

